

Rujzdesign

2025/26



1	Intro / Uvod
4-21	
2	Aluminium products / Izdelki iz aluminija
22-139	
3	Metal handles and knobs / Kovinski ročajji in gumbi
140-179	
4	Wooden handles and knobs / Leseni ročajji in gumbi
180-189	
5	Leather handles and knobs / Usnjeni ročajji in gumbi
190-193	
6	Plastic handles and knobs / Plastični ročajji in gumbi
194-205	
7	Hangers / Obešalniki
206-227	
8	Cubus shelf system / Cubus polični sistem
228-237	
9	Legs and leg frame system / Noge in podložni sistemi
238-249	
10	Galvanisation and custom products / Galvanizacija in izdelki po naročilu
250-255	

Legend
Legenda



Aluminium
Aluminij



Metal
Kovina



Plastic
Plastika



Wood
Les



Glass
Steklo



Leather
Usnje



Carbon
Karbon

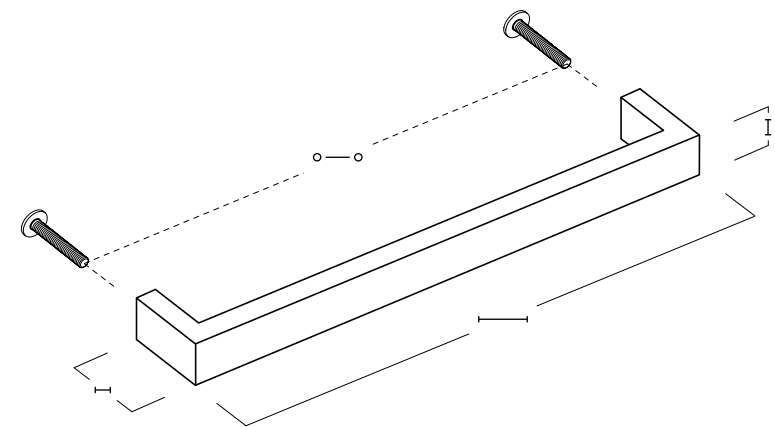

362.20

Article code
Šifra artikla



Distance between screws
Medvijajčna razdalja

Lx

Custom length
Dolžina po naročilu



Length
Dolžina



Height
Višina



Depth
Globina























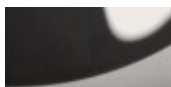

Diameter
Premer











Anodized surface treatments
Eloksirane površinske obdelave

					
031 MCrE 	091 MCrESat 	096 Sat2 	055 Silver 	047 NiSatE 	097 NiSatE2 
					
314 BNiE 	088 SatBNiE 	309 PBNiE 	034 MCrNE 	049 SatCrNE 	345 PMCrNE 
					
305 CuE 	036 SatCuE 	310 PCuE 	317 AuE2 	316 SatAuE2 	343 PAuE2 
					
053 SilverP 	094 SilverPHG 	318 BronzE 	319 SatBronzE 	344 PMBronzE 	











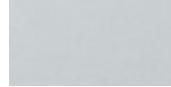

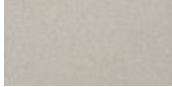





















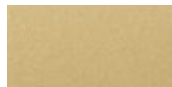









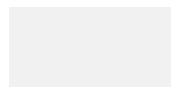
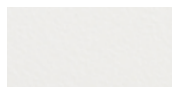









Galvanic surface treatments
Galvanske površinske obdelave

					
012 Cr 	020 MCrG 	016 MNiG 	013 Ni 	026 NiSat 	035 NiSatM 
					
023 BNiG 	087 BNiGM 	321 PCuG 	011 Au 	322 MAuG 	



Woods and wooden finishes
Vrste lesa in njihove površinske obdelave

				
215 Oak 	189 Oak Wenge 	102 Beech Natur 	105 Beech Toned P 	240 Walnut Natur 

Painted finishes
Lakirane površinske obdelave

					
021 MCrL 	032 MCrEL 	089 SatMCrL 	017 MNiL 	063 NiL 	062 SNiL 
					
029 SatCrNL 	064 TitL 	311 BNiL 	068 SatNiL 	376 Str3CrnL 	377 Str2GreyL 
					
306 CuL 	076 SatCuL 	328 BronzL 	329 SatBronzL 	028 MAuL 	061 SatAuL 
					
322 MgCrnL 	332 MgWhite 	844 StrWhite 	845 StrCrnL 	842 Bright Mint 	843 Dark Mint 
					
072 Vint 	098 Vint2 	014 BPatL 	015 MsPatL 	330 MsPatL2 	





















































Other painted finishes
Ostale lakirane površinske obdelave

















































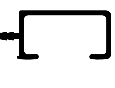
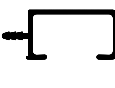
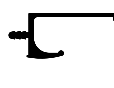

					
024 White 	025 CnrL 	404 Yellow1 	407 Orange1 	408 Orange2 	409 Beige 
					
410 Red1 	412 Pink 	416 Blue 	421 Green2 	423 Green4 	452 Grey1 
					
491 B Violet 	490 B Yellow 	488 B Green 	489 B Blue 		

List of products by page
Seznam izdelkov po straneh

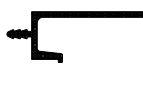
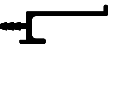
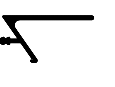

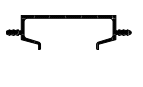
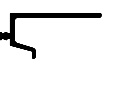





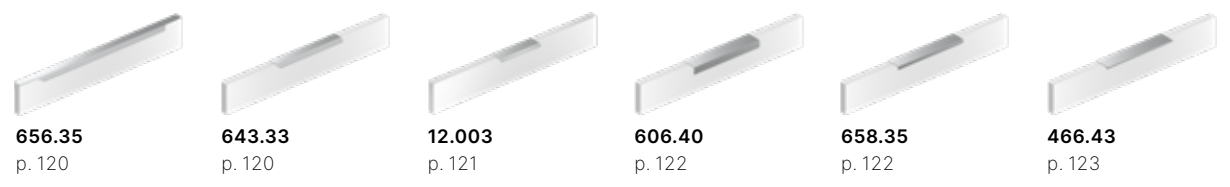
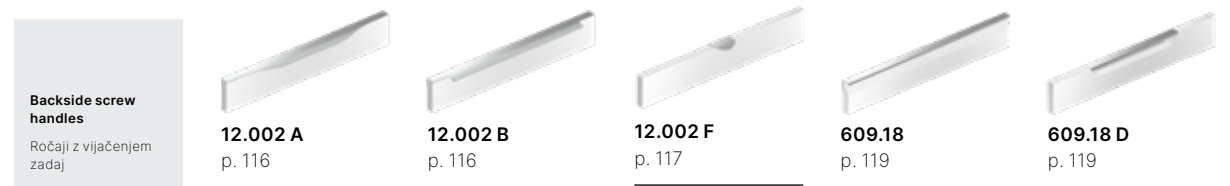
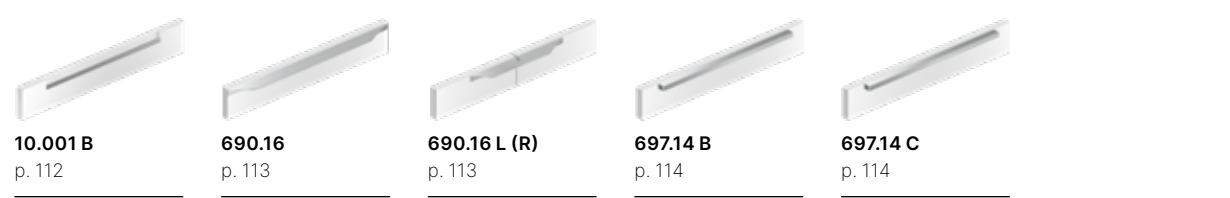
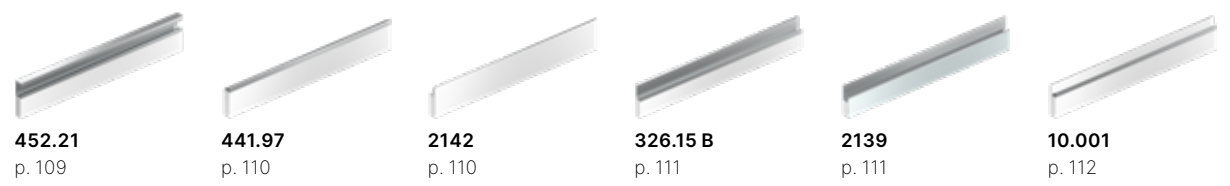
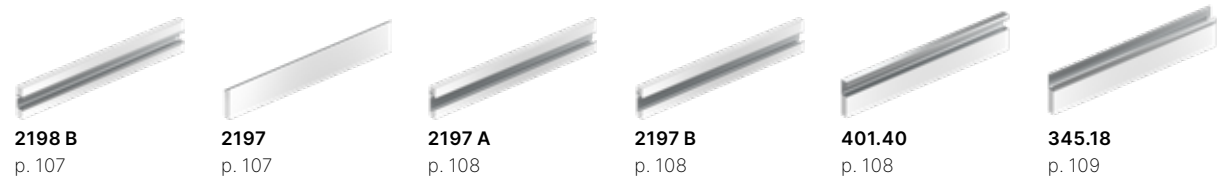
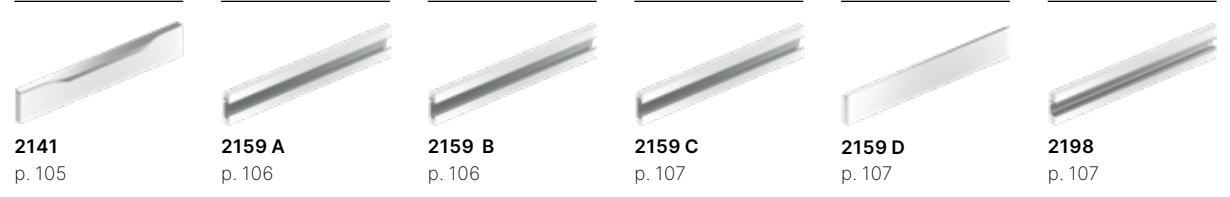
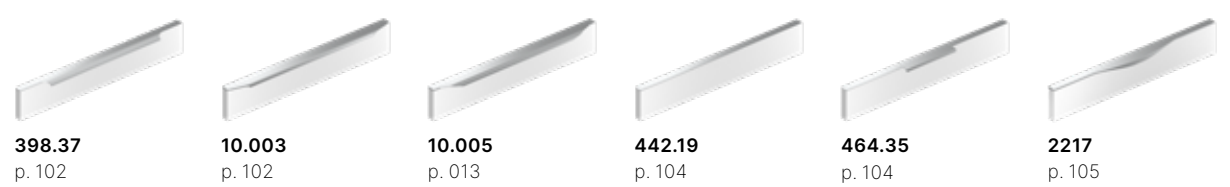
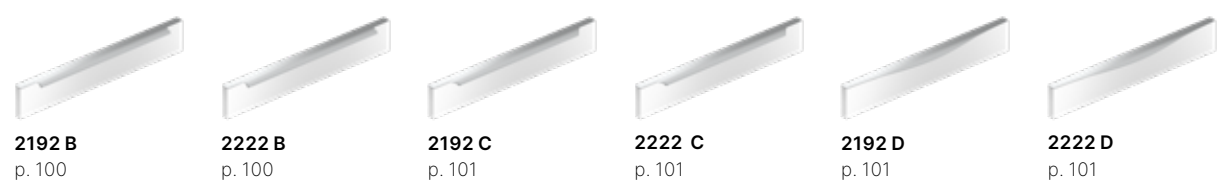
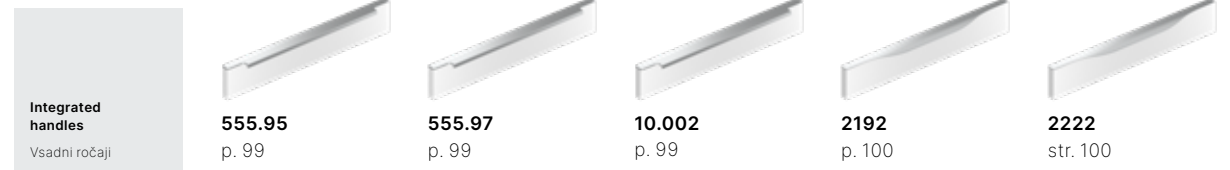
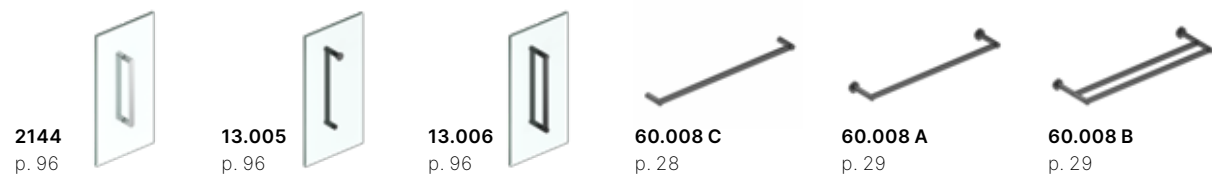
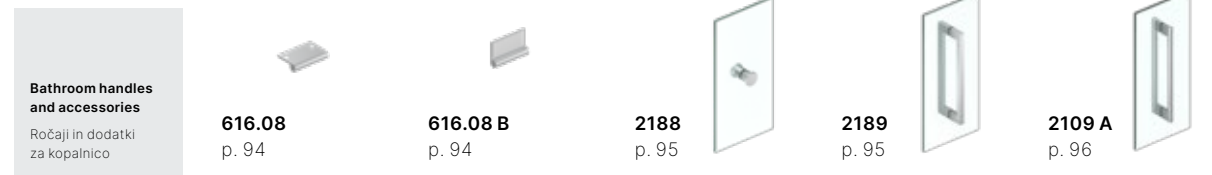
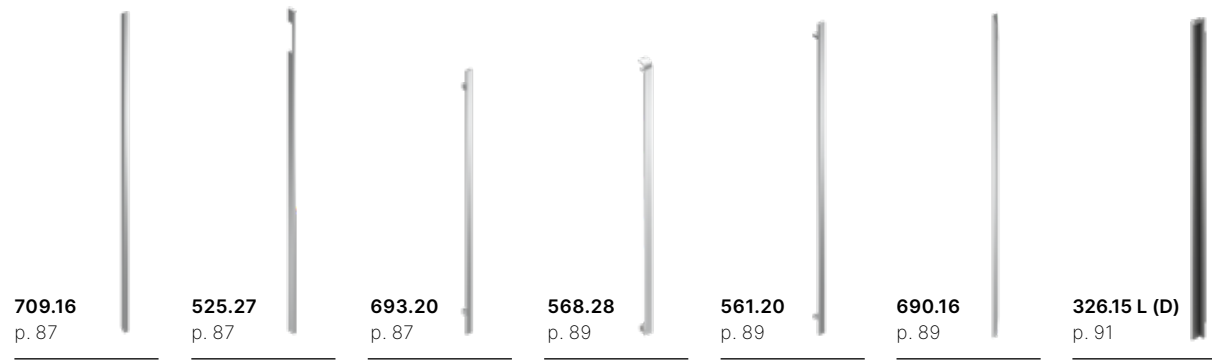
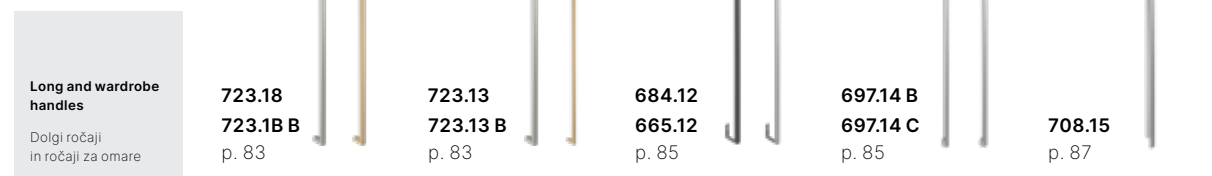
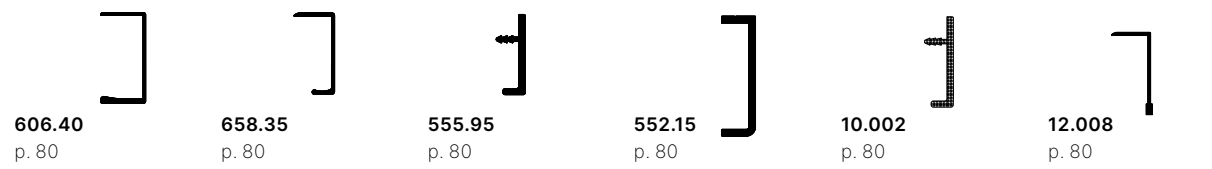

















10.001	112	161.19	173	403.07	130	556.10	188	619.10	42	715.13 D	61	2062	245	2199 C. F	139
10.001 B	112	162.24	173	404.16	66	557.01	168	620.20	51	715.18	61	2064	244	2199 C.IS	139
10.002	80, 99	163.26	172	404.16 B	66	557.02	168	624.12 BL	65	716.15	25	2066	245	2199 C.OS	139
10.003	102	169.30	201, 228	410.20	71	557.03	168	624.12 CL	65	716.15 B	25	2067	244	2199 K	137
10.005	103	170.18	16, 181	414.14	186	557.04	168	627.10	38	718.07	148, 175	2070	245	2199 L	137
10.008	81	171.32	193, 209	415.26 N	159	561.20	49, 89	630.15	177	719.26	148, 174	2072	245	2199 L.E	139
12.002 A	116	199.15	172	416.14	182	564.27	171	631.20 C	53	720.08	147, 174	2081	229	2199 L.F	139
12.002 B	116	199.15 D	172	424.29	42	567.19	72, 171	631.22 B	52	722.09	16, 151, 174	2082	229	2199 L.I	139
12.002 F	117	204.16	191	426.25	43	567.19 B	72	632.27 B	44	722.09 B	16, 177, 183	2084	221	2199 L.IS	139
12.003	121	208.10	63	437.20	165	568.28	89	632.27 BC	92	723.13	56	2087	228	2199 L.O	139
12.008	80, 124	208.10 B	63	441.97	110	569.28	158	634.10	50	723.13 B	57	2088	218	2199 L.OS	139
12.008 B	125	208.10 C	63	442.19	104	570.40	45	636.15	179	801.16	208	2090	230	2199 P	137
13.005	27, 96	213.14	191	444.25	79	570.60	45	638.27 B	50	803.25	171	2092	230	2199 T-18 / T-19	137
13.006	27, 96	219.08	53	446.24 R	162	570.80	45	640.10	55	804.15	171	2100	216	2200 C	138
30.001 A	253	219.10	53	447.20 R	163	572.35	66	643.33	80, 120	805.13	172	2107	79	2200 L	138
30.001 B	253	220.10 + P4	181	448.51 R	178	573.15	35	644.16	36	807.24	172	2109 A	97	2200 P	138
30.001 C	253	222.13	208	449.95	178	573.20	35	646.32	43	809.24	172	2118	104	2202 A	219
30.001 K	253	236.16	182	452.21	78, 109	574.10	35	648.17	49	810.18	193	2120	217	2202 C	219
40.003	220	237.13	190	454.20	174	574.10 C	92	650.12	181	815.14	182	2121	218	2217	105
40.003 B	220	241.08	202	455.18	126	576.28	71	651.24	48	816.70	200	2123	220	2222	100
40.004	218	242.13	62	462.25	161	577.19	197	652.20	171, 216	819.32	175	2124	220	2222 B	100
40.005	218	242.13 B	62	464.35	104	580.26	156	653.15	41, 171	823.18	172	2127	217	2222 C	101
40.006	224	242.13 C	62	466.43	80, 123	581.28	43	656.35	120	825.32	171	2130	221	2222 D	101
40.008	216	259.18	190	469.50	200	583.19	166	657.16	177	826.30	160, 174	2131	217	3002	246
40.009	216	277.32	201	470.50	200	584.19	174	658.35	80, 122	826.30 B	160, 174	2139	78, 111	DR 2116.1	248
40.010	222	285.13	190, 202	471.55	200	586.14	128	665.12	85	826.30 C	178	2141	105	DR 2203.1	248
40.013 A	221	289.26	188	472.52	200	587.25	152	667.20	156	826.30 D	174	2142	110	L1.03.32	193
40.013 B	221	299.08	202	476.15	36, 188	588.25	152	667.20	172, 179	826.30 E	160, 174	2144	97	L1.04.35	193
40.017	25, 215	302.20	208	490.17	74	589.01	178	668.15	156	826.30 F	196	2150	244	L1.05.36	193
40.018 A	214	304.16	163	495.25	158	589.02	178	669.15	155	828.40	209	2151	245	MS 3.28	173
40.018 B	214	311.20	166, 171	496.14	162	590.01	174	673.22	51	829.100	209	2152	246	MS 4.28	173
40.019 A	212	322.16	197	497.22	162	590.02	174	674.15	129	830.10	188	2153	207	MS 5.20	173
40.019 B	212	325.37	79	498.16	157	591.15	196	674.15 B	129	832.28	158, 171	2154	207	MS 5.25	173
40.019 C	212	326.15	127	506.32	201	592.15	196	675.25	74	833.20	172	2155	207	MS 6.25	173
40.019 D	213	326.15 B	78, 111	510.34	174	595.28	32	677.08	153	834.11	171	2156	207	MS 6.38	173
40.019 E	212	326.15 D	127	513.10 B	52	595.28 B	32	678.12	41	836.26	156, 172	2157	207	MS 7.25	173, 183
40.019 F	212	326.15 L	127	516.30	160	596.22	206	679.12 L	65	843.22	200	2158	244	MS 2116.1	248, 249
40.019 G	212	328.20 B	74, 171	516.30 B	160	597.22	206	681.15	182	844.24	200	2159 A	106	MS 2203.1	248, 249
40.020	215	331.16	208	516.30 C	178	598.32	206	682.15	48	845.27	200	2159 A / B	78	NG 2116.1	248
40.021	225	333.08	71	516.30 E	160	599.30	206	683.15	48	846.25	200	2159 B	106	NG 2203.1	248
60.008 A	29	341.10	55	516.30 F	196	600.00	205	684.12	85	847.24	200	2159 C	78, 106	PS 2116.5 / 80	249
60.008 B	29	341.13	55	520.15	32	600.01	205	685.10	36	850.40	172	2159 D	79, 106	PS 2203.5 / 60	249
60.008 C	28	345.18	78, 109	520.20	32	600.02	205	688.12	50	851.30	173, 183	2168	77	PS 2203.5 / 80	249
60.008 V	27	347.20	16, 179, 187	520.20 C	92	600.03	205	689.14	154	851.40	173	2169	77	RE 2116.1	248
80.001	141	354.25	158	520.28	32	600.04	205	690.16	89, 113	855.25	197	2178 R	244	RE 2203.1	248
80.002	141	357.25	73	525.27	44, 87	600.05	205	690.16 L (R)	113	862.37	175	2184 B	244	TA 2090-92 SET	230
80.003	141	360.28	163	527.13	157	600.06	205	691.26	165	2001	226	2187 A	219	U1.150	192
104.14	201	361.25	161	527.13 B	157	600.07	205	692.18	167	2004	227	2187 C	219	U2.135	192
106.14	201	362.21	161, 175	528.03	169	600.08	205	693.20	49, 87	2010	228	2188	95	U2.140	192
109.20	201	362.21 A	161, 175	529.27	153	600.09	205	694.16	155	2013	227	2189	95	U2.150	192, 209
114.30	183, 193, 209	362.21 B	175	530.24	202	601.26	207	696.15	155	2014	222	2192	79, 100	U6.56/45	133
114.30 + P3	183, 193	362.21 C	175	531.24	73	604.27	165	697.14 B	85, 114	2017	246	2192 B	100	U6.137/45	133
117.30	201	362.21 D	161, 175	534.25	44	606.40	80, 122	697.14 C	85, 114	2018	227	2192 C	101	U7.180/40	132
118.30	193, 209	367.20	172	536.16	157	609.18	119	698.20	33	2028	222	2192 D	101	U9.41/41	134
128.18	182	369.16	39	541.15	187	609.18 D	119	700.14	154	2030	227	2197	79, 107	U9.175/55	134
132.25 D	193, 201	375.24	70	546.12	39	611.08	69	703.14	152	2033	217	2197 A	79, 108	U10/15	77
144.32	193	386.20	166	546.12 B	39	611.08 B	69	708.15	47, 87	2037	217	2197 B	79, 108	U11.001/35	134
149.35	193	387.20	166	550.10	38	613.27 B	70, 171, 187	709.16	46, 87	2045	223	2198	107	U11.001/50	134
154.40	200	390.25	70	552.15	80	614.16	51	713.12	42	2046	223	2198 / B	78	U11.003	130
155.40	200	396.25	161	553.28	52	616.08	94	715.13 / 1	61	2053	217	2198 B	107	U11/14	77, 128
157.16	197	398.37	102	555.95	80, 99	616.08 B	94	715.13 B	61	2057	246	2199 C	137	U12AC	132
160.12	173	401.40	78, 108	555.97	99	618.15	41	715.13 C	61	2059	246	2199 C.E	139	U12BC	132

Aluminium products / Izdelki iz aluminija

















Aluminium handles Aluminijasti ročajji					
	716.15 p. 25	716.15 B p. 25	520.28 p. 32	520.20 p. 32	520.15 p. 32
					
595.28 p. 32	595.28 B p. 32	689.20 p. 33	574.10 p. 35	573.15 p. 35	573.20 p. 35
					
476.15 p. 36	685.10 p. 36	644.16 p. 36	550.10 p. 38	627.10 p. 38	369.16 p. 39
					
546.12 p. 39	546.12 B p. 39	678.12 p. 41	618.15 p. 41	424.29 p. 42	572.35 p. 66
					
713.12 p. 42	619.10 p. 42	581.28 p. 43	426.25 p. 43	646.32 p. 43	534.25 p. 44
					
525.27 p. 44	632.27 B p. 44	570.40 p. 45	570.60 p. 45	570.80 p. 45	709.16 p. 46
					
708.15 p. 47	651.24 p. 48	683.15 p. 48	682.15 p. 48	648.17 p. 49	693.20 p. 49
					
561.20 p. 49	634.10 p. 50	688.12 p. 50	638.27 B p. 50	673.22 p. 51	620.20 p. 51
					
614.16 p. 51	513.10 B p. 52	553.28 p. 52	631.22 B p. 52	219.08 p. 53	219.10 p. 53

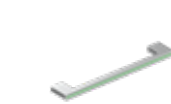























































					
640.10 p. 55	341.10 p. 55	341.13 p. 55	723.13 p. 56	723.13 B p. 57	285.13 p. 58
					
285.13 B p. 58	715.13 B p. 61	715.13 C p. 61	715.13 D p. 61	715.13 / 1 p. 61	715.18 / 1 p. 61
					
242.13 p. 62	242.13 B p. 62	242.13 C p. 62	208.10 p. 63	208.10 B str. 63	208.10 C p. 63
					
679.12 L p. 65	624.12 BL p. 65	624.12 CL p. 65	612.08 p. 66	611.08 str. 69	611.08 B p. 69
					
404.16 p. 66	404.16 B p. 66	631.20 C p. 53	375.24 p. 70	613.27 B p. 70	390.25 p. 70
					
333.08 p. 71	576.28 p. 71	410.20 p. 71	567.19 p. 72	567.19 B p. 72	357.25 p. 73
					
328.20 B p. 74	675.25 p. 74	U10/15 p. 77	U11/14 p. 77	531.24 p. 73	490.17 p. 74
Wardrobe profiles Profili za omare					
	2168 p. 78	2169 p. 78	401.40 p. 78	452.21 p. 78	345.18 p. 78
					
2198 B p. 78	2198 p. 78	2139 p. 78	326.15 B p. 78	2197 B p. 79	2197 A p. 79
					
2159 C p. 78	2159 B p. 78	2159 A p. 78	2159 D p. 79	2197 p. 79	2107 p. 79





























Integrated handles Utopni ročaji	 326.15 p. 126	 455.18 p. 127	 326.15 L p. 127	 326.15 D p. 127	 U11 / 14 p. 128	
	 586.14 p. 128	 674.15 p. 129	 674.15 B p. 129	 403.07 p. 130	 U11.003 p. 130	 U12AC (BC) p. 132
	 U7.180/40 p. 132	 U6.56/45 p. 133	 U6.137/45 p. 133	 U9.41/41 p. 134	 U9.175/55 p. 130	 U11.001/35 p. 130
	 U11.001/50 p. 134					
Gola - profile systems Gola - profilni sistemi	 2199 L p. 137	 2199 C p. 137	 2200 L p. 138	 2200 C p. 138	 2200 P p. 138	
Luggage rack bars Zaščitni drsniki	 80.001 p. 141	 80.002 p. 141	 80.003 p. 141			





























Metal handles and knobs / Kovinski ročaji in gumbi

Metal handles Kovinski ročaji	 720.08 p. 147	 719.26 p. 148	 718.07 p. 148	 722.09 p. 151	 587.25 p. 152	
	 588.25 p. 152	 703.14 p. 152	 529.27 p. 153	 677.08 p. 153	 700.14 p. 154	 689.14 p. 154
	 669.15 p. 155	 694.16 p. 155	 696.15 p. 155	 668.15 p. 156	 580.26 p. 156	 667.20 p. 156









 498.16 p. 157	 536.16 p. 157	 527.13 p. 157	 527.13 B p. 157	 495.25 p. 158	 354.25 p. 154	
 569.28 p. 158	 415.26 N p. 159	 516.30 p. 160	 516.30 B p. 160	 516.30 E p. 160	 361.25 p. 161	
 462.25 p. 161	 396.25 p. 161	 496.14 p. 162	 497.22 p. 162	 446.24 R p. 162	 304.16 p. 163	
 360.28 str. 163	 447.20 R p. 163	 604.27 p. 165	 437.20 p. 165	 691.26 p. 165	 583.19 p. 166	
 386.20 str. 166	 387.20 p. 166	 692.18 p. 167	 557.02 p. 168	 557.01 p. 168	 557.03 p. 168	
 557.04 p. 168	 590.02 p. 169	 528.03 p. 169				
Metal knobs Kovinski gumbi	 652.20 p. 171	 832.28 p. 171	 653.15 p. 171	 803.25 p. 171	 825.32 p. 171	
	 834.11 p. 171	 564.27 p. 171	 804.15 p. 171	 311.20 p. 171	 613.27 B p. 171	 567.19 p. 171
	 328.20B p. 171	 807.24 p. 172	 836.26 p. 172	 367.20 p. 172	 667.20 p. 172	 199.15 p. 172
 199.15 D p. 172	 163.26 p. 172	 809.24 p. 172	 823.18 p. 172	 805.13 p. 172	 833.20 p. 172	

					
850.40 p. 172	851.40 p. 173	851.30 p. 173	160.12 p. 173	161.19 p. 173	162.24 p. 173
					
MS 3.28 p. 173	MS 5.20 p. 173	MS 5.25 p. 173	MS 7.25 p. 173	MS 4.28 p. 173	MS 6.25 p. 173
					
MS 6.38 p. 173	826.30 p. 174	826.30 B p. 174	826.30 D p. 174	826.30 E p. 174	590.01 p. 174
					
590.02 p. 174	720.08 p. 174	722.09 p. 174	719.26 p. 174	584.19 p. 174	454.20 p. 174
					
510.34 p. 174	362.21 p. 175	362.21 A p. 175	362.21 B p. 175	362.21 C p. 175	362.21 D p. 175
					
819.32 p. 175	718.07 p. 175	862.37 p. 175			
Vintage style Staran stil					
	630.15 p. 177	722.09 B p. 177	657.16 p. 177	448.51 R p. 178	449.95 p. 178
For more handle models in vintage and classic styles, please visit Za več ročajev v staranem in klasičnem stilu, obiščite rujzdesign.com					
	667.20 p. 178	589.01 589.02 p. 178	826.30 C 516.30 C p. 178	636.15 p. 179	347.20 p. 179
Classic style Klasičen stil					
	220.10 + P4 p. 181	650.12 p. 181	236.16 128.18 p. 182	815.14 p. 182	416.14 p. 182
					
681.15 p. 182	170.18 p. 181	114.30 114.30 + P3 p. 183	851.30 p. 183	MS 7.25 p. 183	722.09 B p. 183













































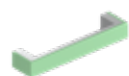







Wooden handles and knobs / Leseni ročaji in gumbi

					
414.14 p. 186	613.27 B p. 187	541.15 p. 187	347.20 p. 187	476.15 p. 188	289.26 p. 188
					
166.10 p. 188	556.10 p. 188	830.10 p. 188	259.18 p. 190	285.13 p. 190	237.13 str. 190
					
204.16 p. 191	213.14 p. 191	U1.150 p. 192	U2.135 p. 192	U2.140 p. 192	U2.150 str. 192
					
810.18 p. 193	132.25 D p. 193	144.32 p. 193	149.35 p. 193	171.32 p. 193	114.30 p. 193
					
114.30+P3 p. 193	118.30 p. 193	L1.05.36 p. 193	L1.03.32 p. 193	L1.04.35 p. 193	























































Leather handles and knobs / Usnejni ročaji in gumbi

					
591.15 p. 196	592.15 p. 196	516.30 F p. 196	826.30 F p. 196	322.16 p. 197	577.19 p. 197
					
855.25 p. 197	157.16 p. 197				

Plastic handles and knobs / Plastični ročaji in gumbi

 154.40 p. 200	 155.40 p. 200	 843.22 p. 200	 846.25 p. 200	 844.24 p. 200	 845.27 p. 200
 472.52 p. 200	 816.70 p. 200	 847.24 p. 200	 469.50 p. 200	 470.50 p. 200	 471.55 p. 200
 106.14 p. 201	 109.20 p. 201	 117.30 p. 201	 506.32 p. 201	 132.25 D p. 201	 104.14 p. 201
 277.32 p. 201	 169.30 p. 201	 285.13 p. 202	 530.24 p. 202	 241.08 p. 202	 299.08 p. 202
 600.00 p. 205	 600.01 p. 205	 600.02 p. 205	 600.03 p. 205	 600.04 p. 205	 600.05 p. 205
 600.06 p. 205	 600.07 p. 205	 600.08 p. 205	 600.09 p. 205	 599.30 p. 206	 598.32 p. 206
 596.22 p. 206	 597.22 p. 206	 2154 p. 207	 2153 p. 207	 2155 p. 207	 601.26 p. 207
 2156 p. 207	 2157 p. 2037	 222.13 p. 208	 302.20 p. 208	 331.16 p. 208	 801.16 p. 208
 118.30 p. 209	 114.30 p. 209	 171.32 p. 209	 U2.150 p. 209	 828.40 p. 209	 829.100 p. 209

Hangers / Obešalniki

 40.019 A p. 212	 40.019 F p. 212	 40.019 B p. 212	 40.019 C p. 212	 40.019 E p. 212	 40.019 G p. 212
 40.019 D p. 213	 40.018 B p. 214	 40.018 A p. 214	 40.020 p. 215	 40.017 p. 215	 40.008 str. 216
 40.009 p. 216	 652.20 p. 216	 2100 p. 216	 2127 p. 217	 2037 p. 217	 2131 str. 217
 2053 p. 217	 2120 p. 217	 2033 p. 217	 40.004 p. 218	 40.005 p. 218	 2088 p. 218
 2121 p. 218	 2202 A p. 219	 2187 A p. 219	 2202 C p. 219	 2187 C p. 219	 40.003 p. 220
 40.003 B p. 220	 2123 p. 220	 2124 p. 220	 40.013 A p. 221	 40.013 B p. 221	 2130 str. 221
 2084 p. 221	 40.010 p. 222	 2028 p. 222	 2014 p. 222	 2046 p. 223	 2045 str. 223
 40.006 p. 224	 40.021 p. 225	 2001 p. 226	 2018 p. 227	 2030 p. 227	 2013 p. 227
 2004 p. 227	 2087 p. 228	 169.30 p. 228	 2010 p. 228	 2081 p. 229	 2082 p. 229



2092
p. 230



2090
p. 230



TA 2090-92 SET
p. 230

Cubus shelf system / Cubus polični sistem

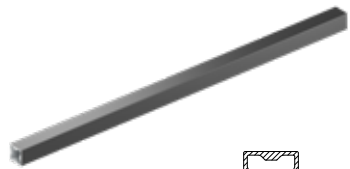

Horizontal profile
Horizontalni profil

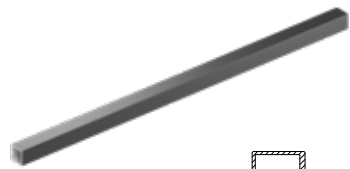

Vertical profile
Vertikalni profil



Sliding door profile
Profil za drsna vrata



Customisable shelf system
p. 233

Legs and leg frame system / Noge in podložni sistemi



2178 R
p. 244



2184 B
p. 244



2150
p. 244



2158
p. 244



2064
p. 244



2067
p. 244



2062
p. 245



2072
p. 245



2151
p. 245



2066
p. 245



2070
p. 245



2059
str. 246



MS 2203.1
p. 248



MS 2116.1
str. 248



2057
p. 246



2017
p. 246



2152
p. 246



3002
p. 246



NG 2203.2A
p. 248



NG 2116.2A
p. 248



30.001 K
p. 253



30.001 A
p. 253

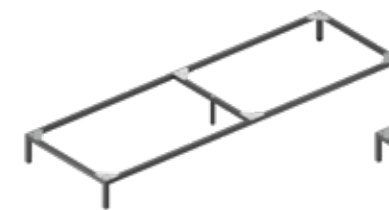

30.001 B
p. 253

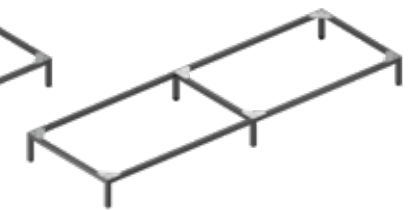

30.001 C
p. 253

izdelki iz aluminija



aluminium products



Dot Collection / Kolekcija "Dot"



40.017

Hanger / Obešalnik

—	15	I	68
—		I	32

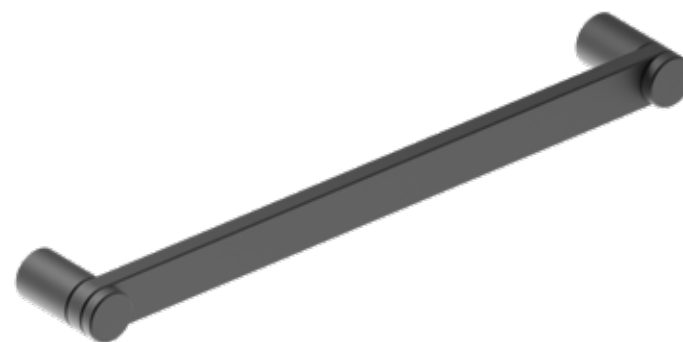

716.15

—	143	175	207	335	415	615	I	15
○—○	128	160	192	320	400	600	I	31



716.15 B

—	175	207	335	463	I	15
○—○	160	192	320	448	I	27



Glass door handles / Ročaja za steklena vrata

13.005

—	179	211	243	339	419
○—○	160	192	224	320	400

I	15 / 23
↔	31 / 24

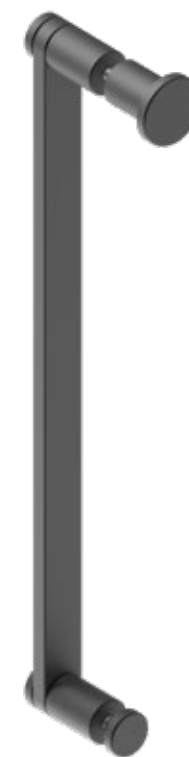

13.006

—	175	207	239	335	415	I	15 / 15
○—○	160	192	224	320	400	↔	31 / 31

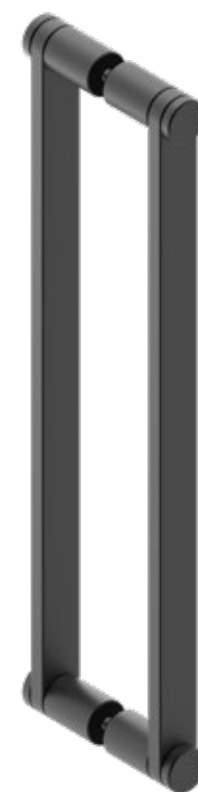

60.008 V

Toilet paper holder / Držalo za toaletni papir

—	180	I	15 / 30
○—○	150	↔	75



Towel rails / Držala za brisače

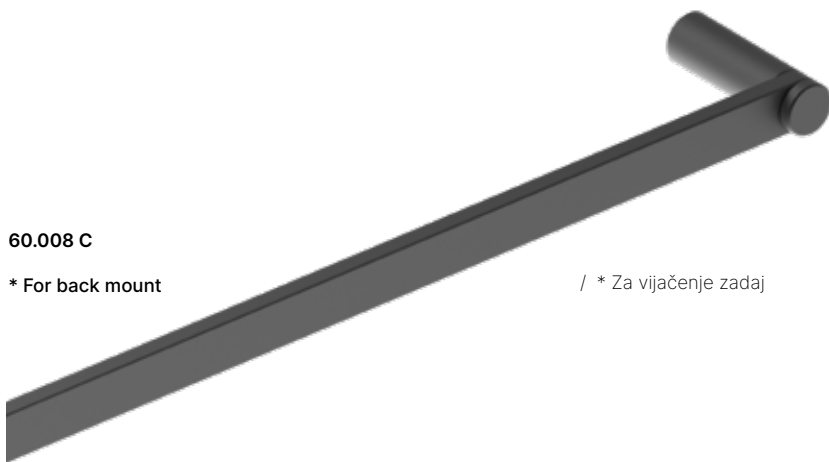

60.008 C

* For back mount

/ * Za vijačenje zadaj

— —	415	615	765	I	15
○—○	400	600	750	↳	31

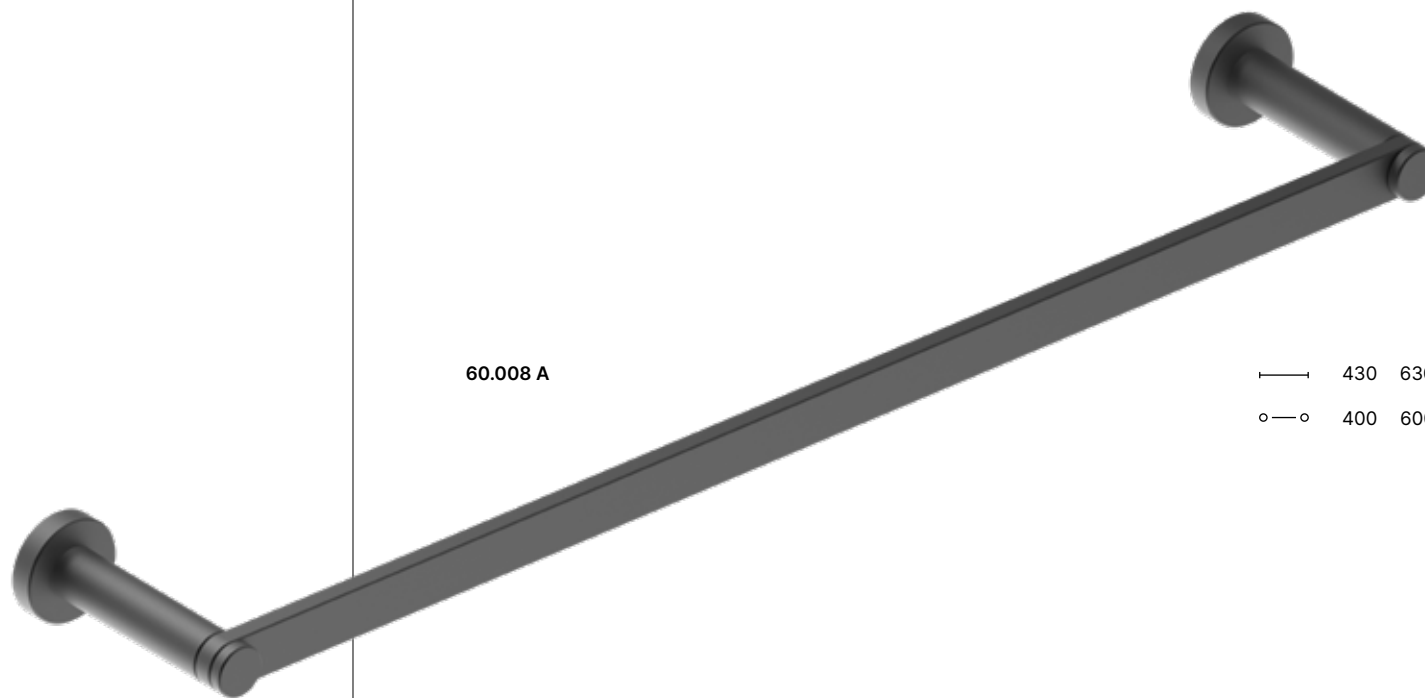

60.008 A

— —	430	630	780	I	15 / 30
○—○	400	600	750	↳	75

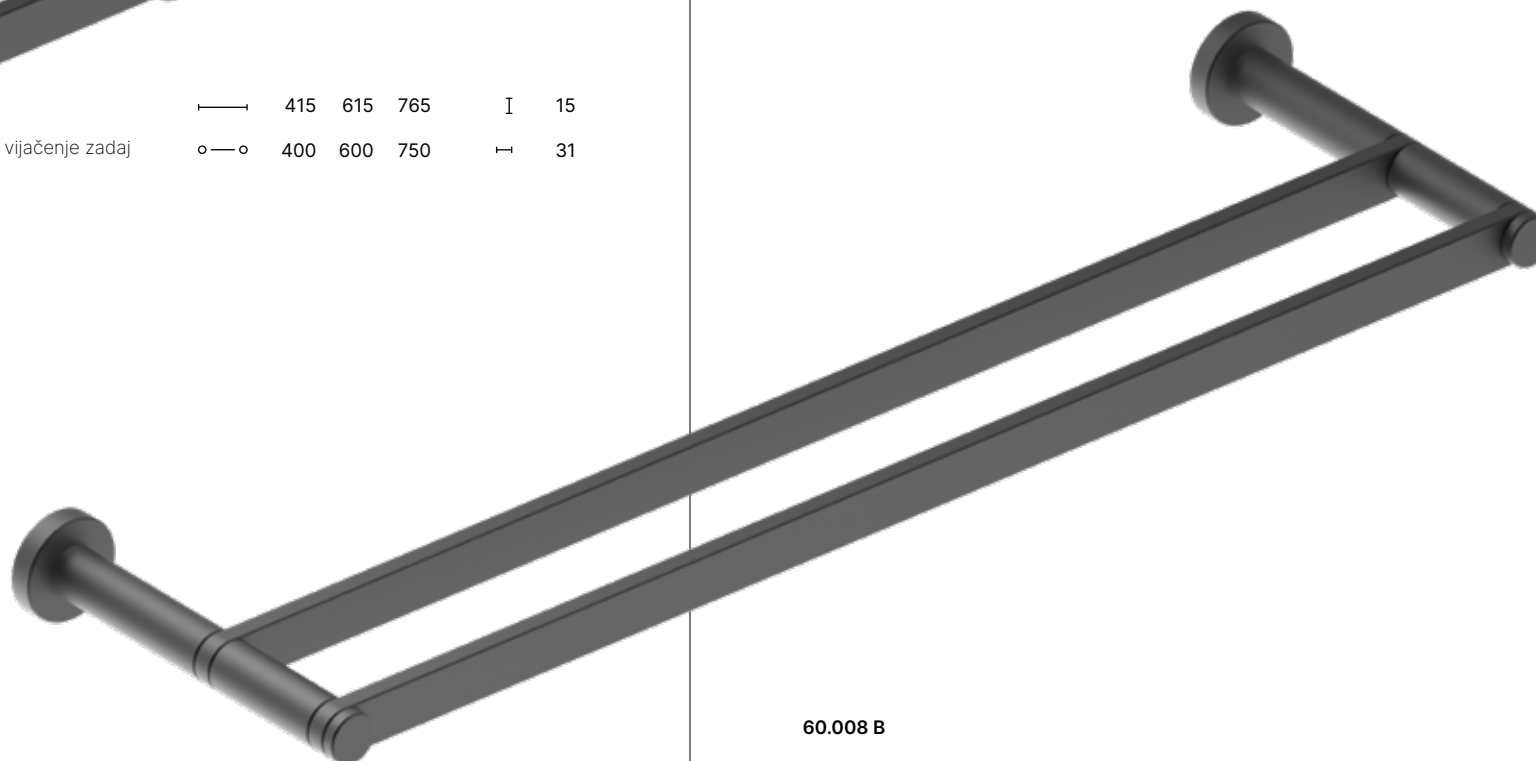

60.008 B

— —	430	630	780	I	15 / 30
○—○	400	600	750	↳	121



520.28

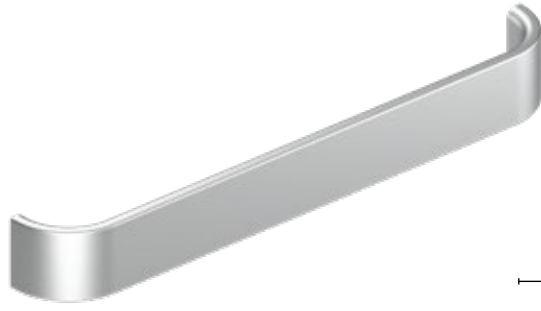

—	167	231	262	327	423	/Lx	I	28
○—○	160	224	256	320	416	/Lx	↳	26

520.20

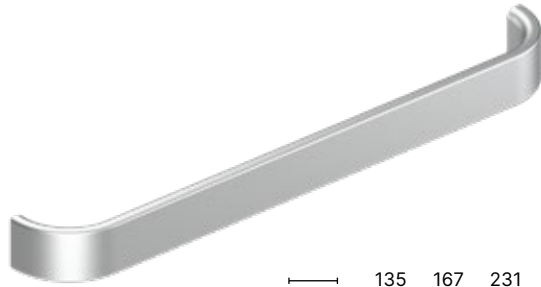

—	135	167	231	277	327	377	423	477	627	/Lx	I	20
○—○	128	160	224	270	320	370	416	470	620	/Lx	↳	27

520.15



—	135	167	231	327	423	/Lx	I	15
○—○	128	160	224	320	416	/Lx	↳	27

595.28

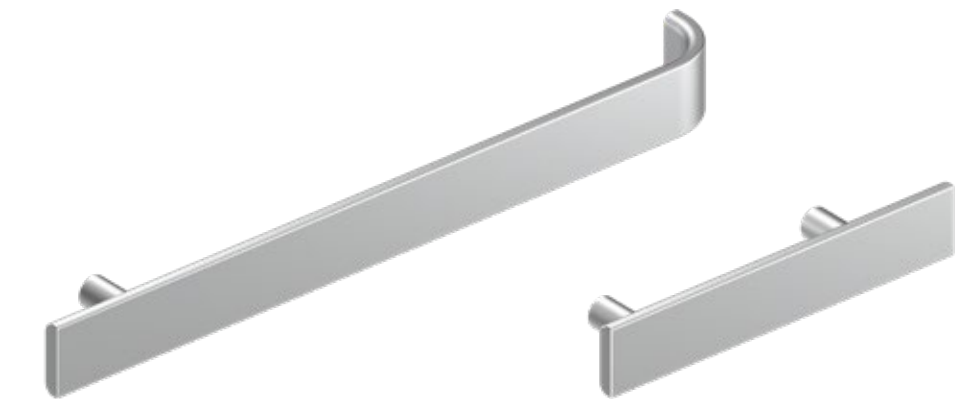

—	120	300	400	/Lx	I	28
○—○	96	256	352	/Lx	↳	30

595.28 B



—	155	/Lx	I	28
○—○	96	/Lx	↳	30



698.20



—	168	232	328	424	488	/Lx	I	20
○—○	160	224	320	416	480	/Lx	↳	28



574.10

—	138	170	234	330	426	/Lx	I	10
○—○	128	160	224	320	416	/Lx	↳	32



573.15

—	135	167	231	327	423	/Lx	I	15
○—○	128	160	224	320	416	/Lx	↳	28



573.20

—	135	167	231	263	327	423	487	/Lx	I	20
○—○	128	160	224	256	320	416	480	/Lx	↳	32



476.15

— —	181	281	331	381	481	/Lx	I	15
○—○	170	270	320	370	470	/Lx	— —	38



685.10

— —	138	170	202	234	266	298	330	I	10
○—○	128	160	192	224	256	288	320	— —	30



644.16

— —	141	173	237	283	333	383	433	483	583	683	783	883	/Lx	I	16
○—○	128	160	224	270	320	370	420	470	570	670	770	870	/Lx	— —	32





550.10



—	138	170	202	234	330	426	490	/Lx	I	10
○—○	128	160	192	224	320	416	480	/Lx	↳	34

627.10

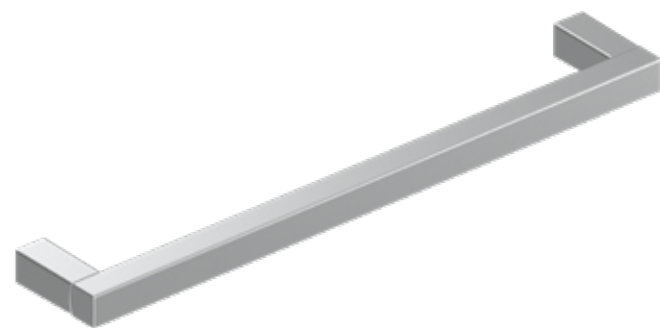

—	138	194	294	344	394	494	694	794	894	1094	/Lx	I	10
○—○	128	184	284	334	384	484	2x342	2x392	2x442	2x542	/Lx	↳	32

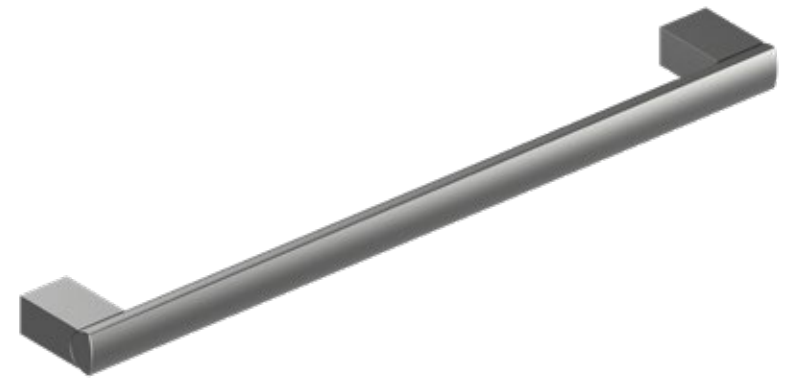

369.16

—	153	195	249	295	303	345	395	495	695	795	857	895	1095	/Lx	I	16
○—○	128	170	224	270	288	320	370	470	670	770	832	870	1070	/Lx	↳	37

546.12



546.12 B



546.12 / B

—	140	172	204	236	332	428	524	620	812	1004	/Lx	I	12
○—○	128	160	192	224	320	416	512	608	800	992	/Lx	↳	33



678.12

—	160	280	380	580	/Lx	I	12
○—○	128	160	256	480	/Lx	↳	35



618.15

—	155	287	/Lx	I	15
○—○	96	192	/Lx	↳	25

653.15

—	15	I	35
○—○	16	↳	25



424.29

— —	143	185	207	235	285	335	385	485	/Lx	I	17
○—○	128	170	192	220	270	320	370	470	/Lx	↳	29



713.12

— —	183	215	279	375	471	567	695	/Lx	I	12
○—○	128	160	224	320	416	512	640	/Lx	↳	33

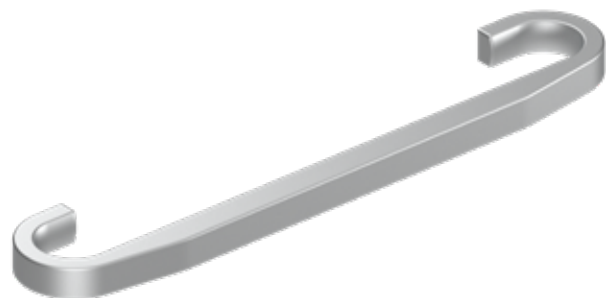

619.10

— —	198	308	408	/Lx	I	10
○—○	160	270	370	/Lx	↳	37



581.28

— —	136	168	232	328	424	488	/Lx	I	28
○—○	128	160	224	320	416	480	/Lx	↳	30



426.25

— —	143	185	207	235	285	335	385	485	/Lx	I	24
○—○	128	170	192	220	270	320	370	470	/Lx	↳	25



646.32

— —	172	222	272	322	372	472	/Lx	I	12
○—○	160	210	260	310	360	460	/Lx	↳	32



534.25

┌──┐	200	300	350	400	500	650	/Lx	I	23
○—○	170	270	320	370	470	620	/Lx	┌─┐	23

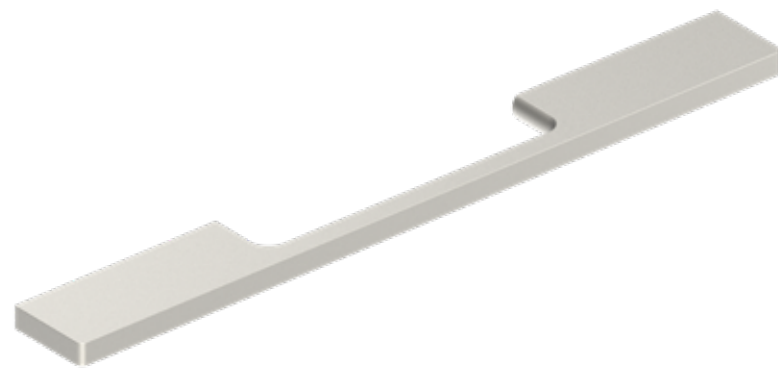

525.27

┌──┐	66	175	240	275	325	375	475	675	875	/Lx	I	7
○—○	32	128	160	192	224	256	288	3×192	3×256	/Lx	┌─┐	27



632.27 B

┌──┐	200	260	360	460	/Lx	I	7
○—○	160	224	320	416	/Lx	┌─┐	27

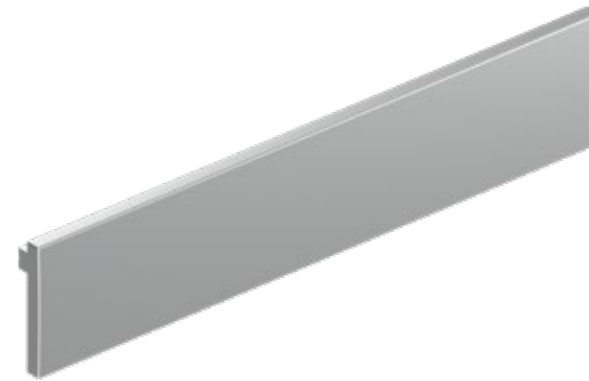

570.40

┌──┐	40	70	142	192	242	292	342	392	492	/Lx	I	40
○—○	16	32	96	128	160	224	288	320	352	/Lx	┌─┐	26



570.60

┌──┐	60	/Lx	I	60
○—○	16	/Lx	┌─┐	26



570.80

┌──┐	80	/Lx	I	80
○—○	32	/Lx	┌─┐	26





709.16

—	45	100	150	200	250	300	350	400	500	1090	/Lx	I	16
○—○	16	64	96	128	160	192	224	320	416	2x400	/Lx	↳	18

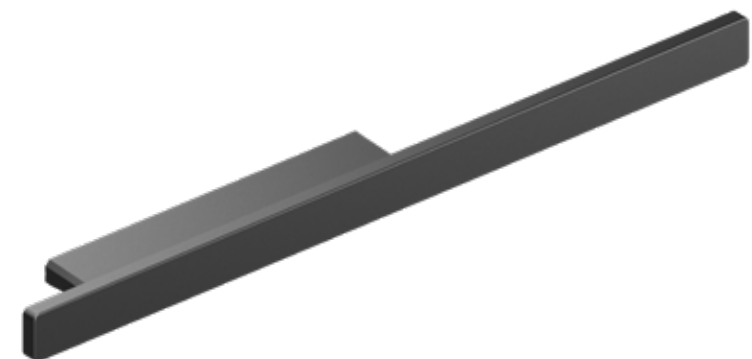
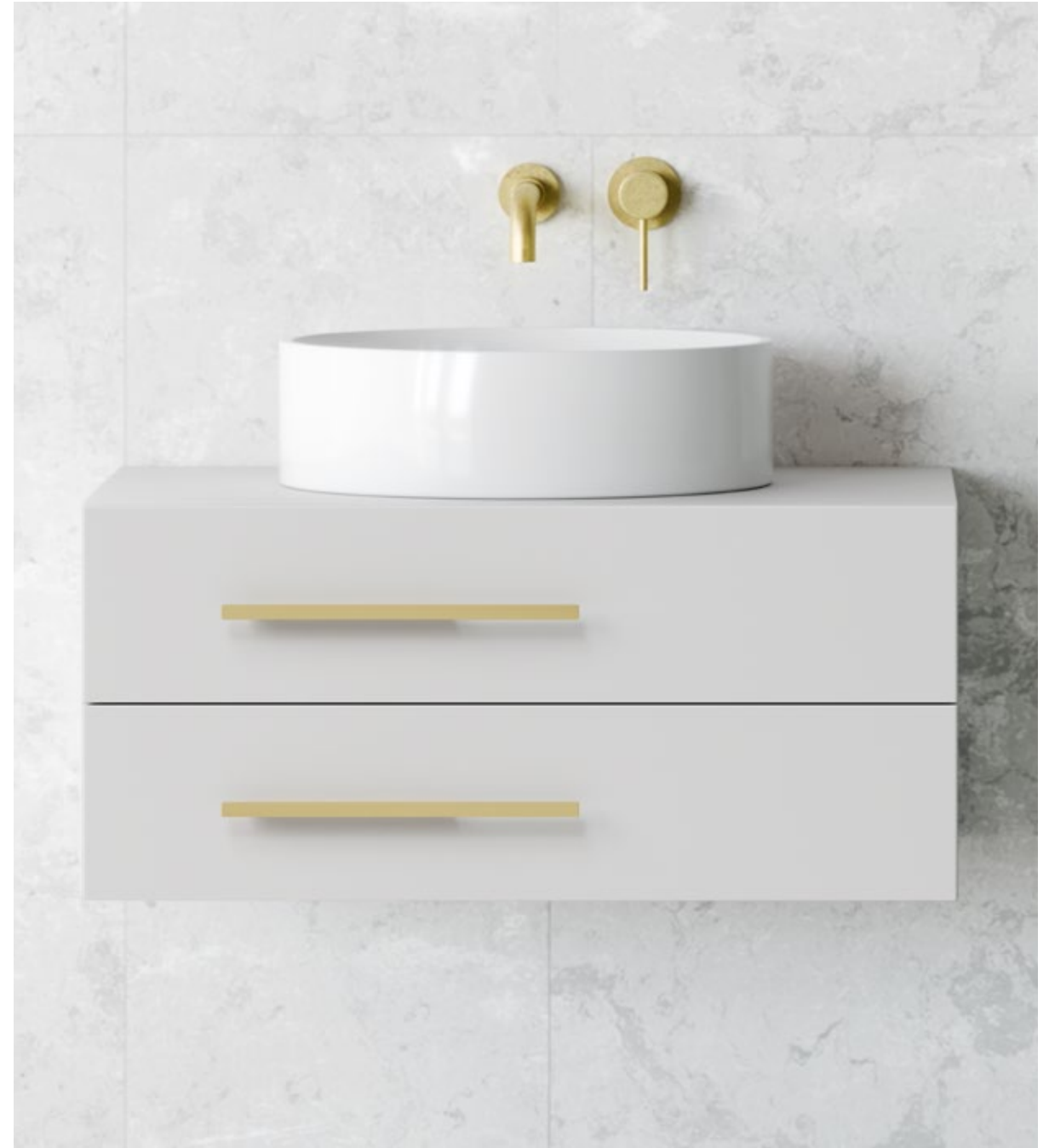

708.15

—	200	250	300	350	/Lx	I	15
○—○	64	96	128	160	/Lx	↳	26

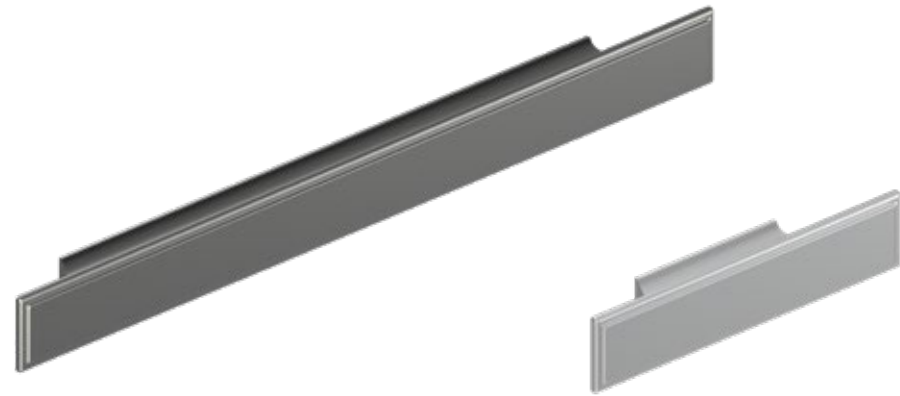

651.24

— —	110	180	250	/Lx	I	24
○—○	32	96	160	/Lx	↳	20



683.15

— —	90	190	290	340	390	490	590	690	790	/Lx	I	15
○—○	32	128	192	224	256	320	448	512	640	/Lx	↳	17



682.15

— —	97	197	297	347	397	497	597	697	797	/Lx	I	15
○—○	64	160	224	256	320	416	488	576	672	/Lx	↳	17



648.17

— —	160	210	260	360	460	/Lx	I	17
○—○	128	160	224	320	416	/Lx	↳	23

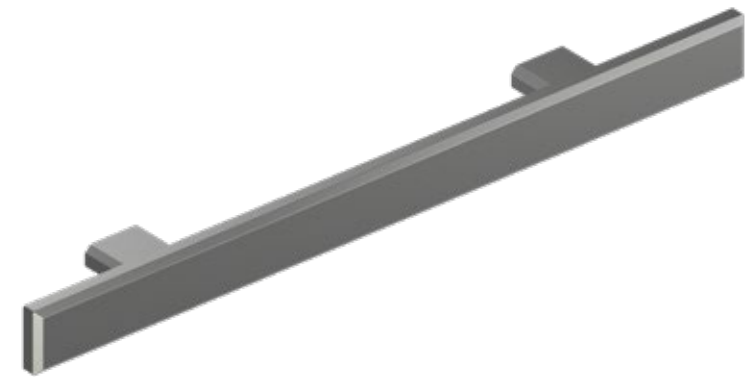

693.20

— —	100	200	250	300	400	500	600	700	900	/Lx	I	20
○—○	10	120	150	170	270	370	470	570	770	/Lx	↳	28

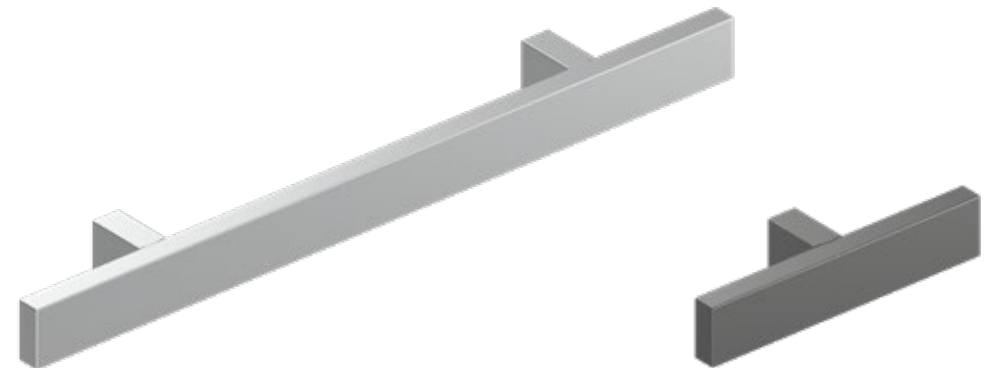

561.20

— —	100	164	210	260	310	360	460	660	760	860	1060	/Lx	I	20
○—○	1	64	110	160	210	260	360	560	660	760	960	/Lx	↳	29



634.10

— 150 182 246 278 342 438 492 /Lx I 10
 ○—○ 128 160 224 256 320 416 470 /Lx H 29



688.12

— 185 249 345 441 537 645 /Lx I 12
 ○—○ 160 224 320 416 512 620 /Lx H 33



638.27 B

— 177 239 I 13
 ○—○ 160 224 H 27



673.22

— 182 214 246 342 438 /Lx I 22
 ○—○ 160 192 224 320 416 /Lx H 29



620.20

— 186 218 282 296 346 396 442 496 646 /Lx I 20
 ○—○ 160 192 256 270 320 370 416 470 620 /Lx H 29



614.16

— 186 201 250 301 346 351 401 442 451 501 538 646 /Lx I 16
 ○—○ 160 175 224 275 320 325 375 416 425 475 512 620 /Lx H 35



513.10 B

— —	204	233	430	I	10
○—○	192	224	416	┌	29 35 37



553.28

— —	239	405	I	28
○—○	224	384	┌	24 34

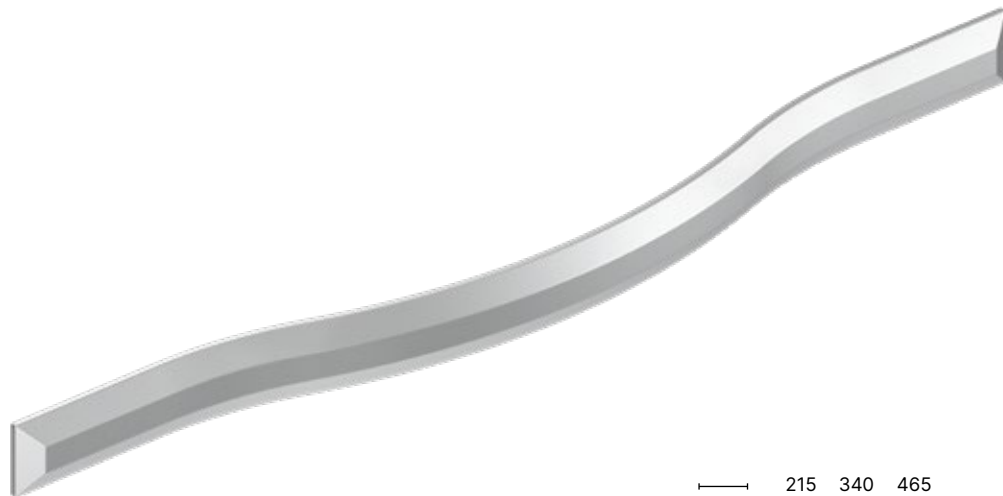

631.22 B

— —	215	340	465	I	22
○—○	192	288	416	┌	29



219.08

— —	113	I	8
○—○	96	┌	24



219.10

— —	150	229	I	10
○—○	128	192	┌	30 31

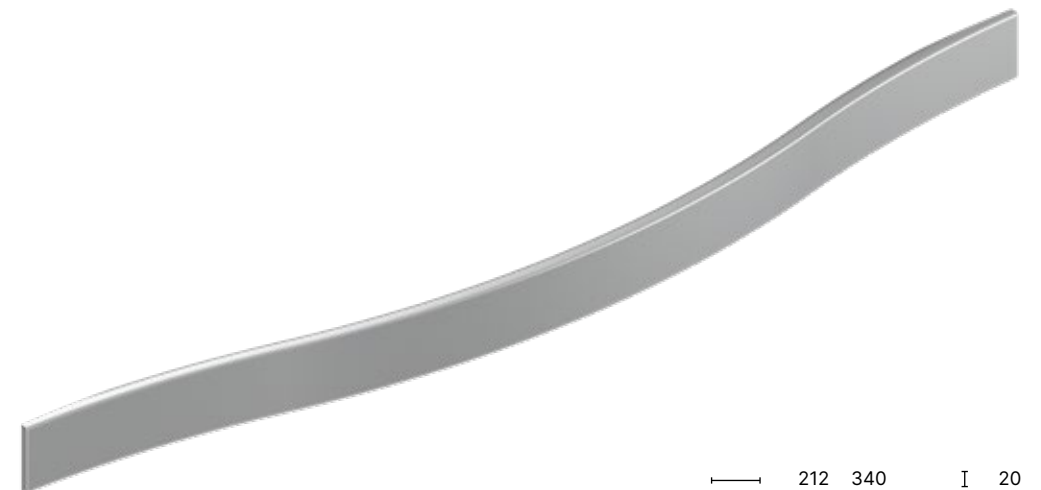

631.20 C

— —	212	340	I	20
○—○	160	256	┌	24 26



640.10

—	170	234	330	426	490	/Lx	I	10
○—○	160	224	320	416	480	/Lx	↳	30



341.10

—	138	170	266	298	394	/Lx	I	10
○—○	128	160	256	288	384	/Lx	↳	32



341.13

—	109	141	173	269	397	525	/Lx	I	13
○—○	96	128	160	256	384	512	/Lx	↳	43



723.13

—	137	201	229	553	1097	I	13
○—○	128	192	320	544	2×544	↳	36



723.13 B

—	137	201	229	553	1097	I	13
○—○	128	192	320	544	2×544	↳	36





285.13

—	103	135	167	199	219	327	/Lx	I	17
○—○	96	128	160	192	288	320	/Lx	↳	31



285.13 B

—	103	135	199	/Lx	I	17
○—○	96	128	192	/Lx	↳	31





715.13 / 1

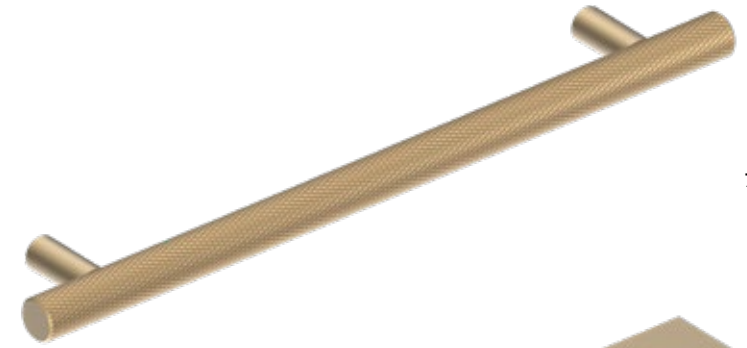

715.13 B



715.13 C

715.13 / 1 / B / C

—	13	177	209	241	305	401	561	753	977	/ Lx	I	13
○—○	1	128	160	192	256	352	512	704	928	/ Lx	↳	(22) 35

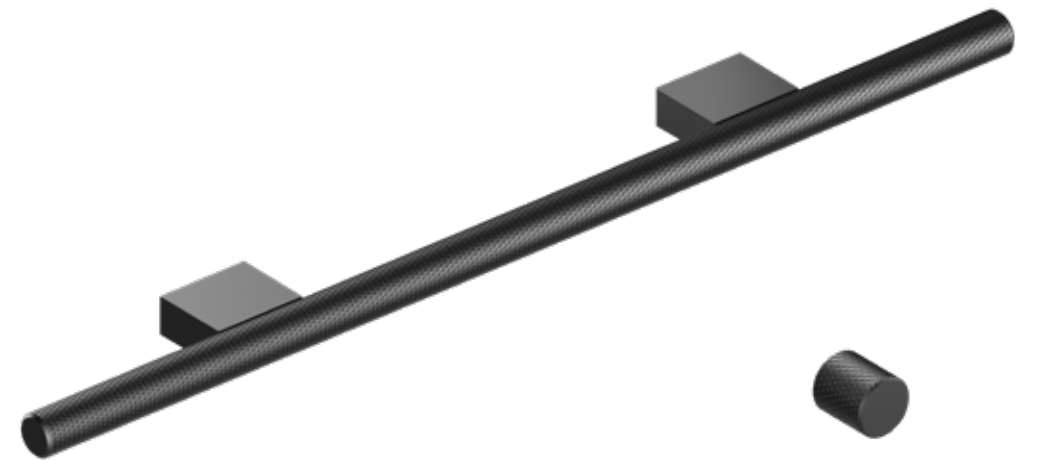

715.13 D

—	96	230	340	460	/ Lx	I	13
○—○	170	128	192	256	/ Lx	↳	35

715.18

—	18	I	18
↳		↳	22



242.13



242.13 B



242.13 C

242.13 / B / C

—	178	210	242	306	402	562	754	978	I	13
○—○	128	160	192	256	352	512	704	928	↳	31 33 34



208.10



208.10 B



208.10 C

208.10 / B / C

—	100	134	178	210	242	274	370	466	658	850	1042	I	10
○—○	64	96	128	160	192	224	320	416	608	800	992	↳	29 30 32



679.12 L

—	168	200	232	264	296	328	424	520	616	712	I	12
○—○	128	160	192	224	256	288	384	480	576	672	↔	34



624.12 BL



624.12 CL

624.12 BL / CL

—	178	210	242	274	306	338	434	530	626	722	/Lx	I	12
○—○	128	160	192	224	256	288	384	480	576	672	/Lx	↔	34



404.16



404.16 B

404.16 / B

—	178	210	306	402	498	594	818	1106	/Lx	I	16	16
○—○	128	160	256	352	448	544	768	1056	/Lx	┌	41	36



572.35

—	148	180	212	276	340	500	660	820	/Lx	I	15	
○—○	128	160	192	256	320	480	640	800	/Lx	┌	35	





612.08 *

—	79	175	239	335	463	655	847	I	10
○—○	64	160	224	320	2×224	2×320	2×416	↳	31

611.08 * / B

—	96	224	288	352	448	576	768	960	I	8
○—○	32	96	160	224	320	2×224	2×320	2×416	↳	28

612.08

* real carbon / pravi karbon

611.08

* real carbon / pravi karbon

611.08 B



375.24

—	52	82	114	148	178	210	338	/Lx	I	14
○—○	32	64	96	128	160	192	320	/Lx	↳	24



613.27 B

—	32	160	224	320	416	/Lx	I	7
○—○	16	128	160	224	320	/Lx	↳	27



390.25

—	40	114	178	210	306	668	/Lx	I	10
○—○	32	96	160	192	288	512	/Lx	↳	25



333.08

—	30	105	168	242	370	466	668	860	1052	/Lx	I	8
○—○	1	96	128	160	256	320	512	608	800	/Lx	↳	20



576.28

—	84	250	300	450	1020	/Lx	I	8
○—○	64	2×96	224	2×192	2×488	/Lx	↳	28



410.20

—	52	82	114	168	210	242	328	854	954	1000	/Lx	I	8
○—○	32	64	96	128	160	192	288	2×400	2×448	2×480	/Lx	↳	20

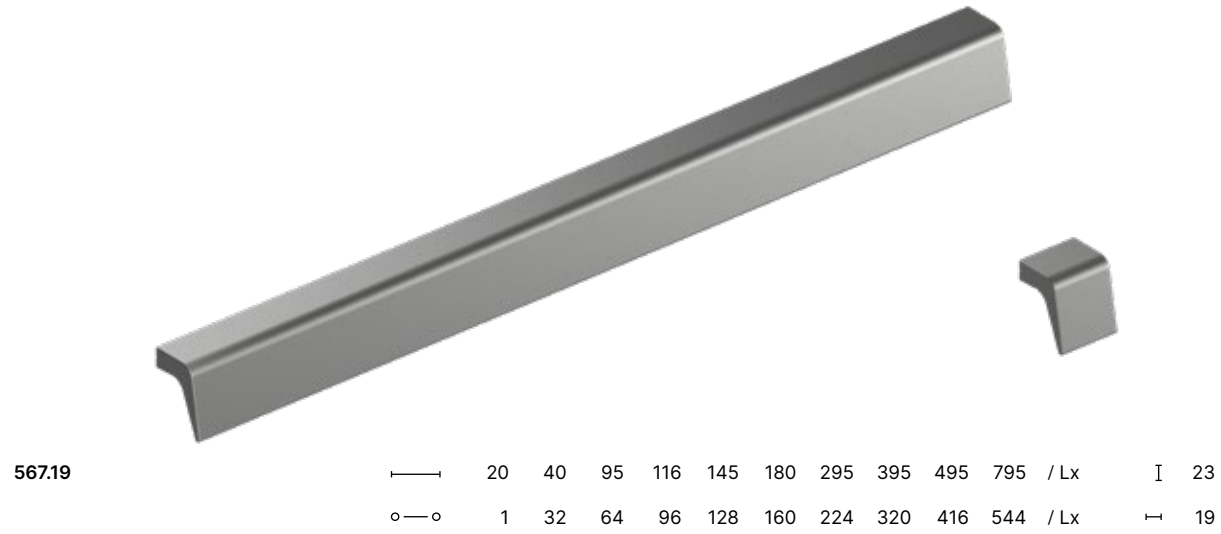

567.19

— —	20	40	95	116	145	180	295	395	495	795	/Lx	I	23
○—○	1	32	64	96	128	160	224	320	416	544	/Lx	↳	19



567.19 B

— —	200	400	/Lx	I	23
○—○	128	224	/Lx	↳	19



357.25

— —	250	383	500	600	788	833	/Lx	I	15
○—○	224	320	400	2×288	2×352	2×384	/Lx	↳	25



531.24

— —	52	85	200	255	300	350	400	500	565	800	1100	/Lx	I	8
○—○	32	64	160	192	2×112	2×144	2×160	2×208	2×192	2×272	2×400	/Lx	↳	24

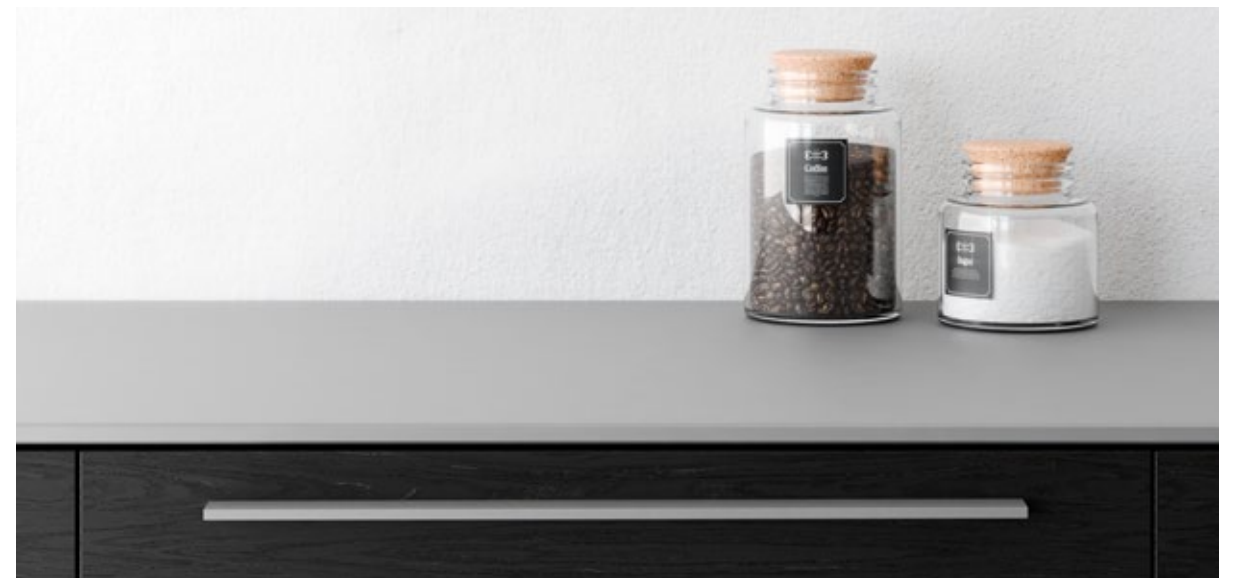

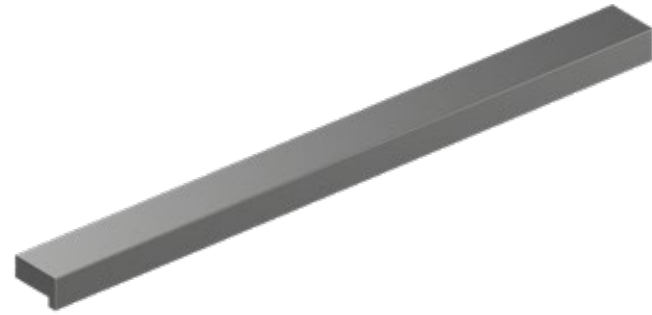

490.17

— —	20	178	210	295	360	495	695	/Lx	I	10
○—○	1	128	160	224	320	416	2x336	/Lx	— —	17

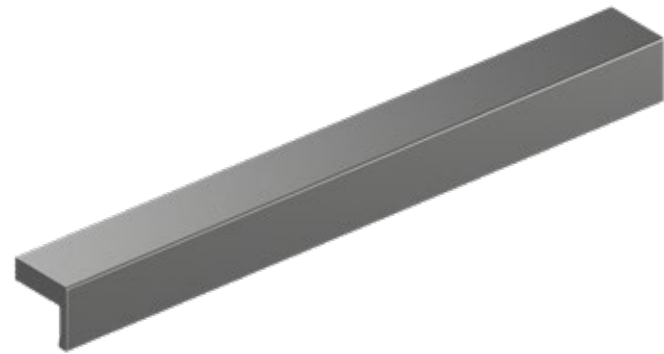

328.20 B

— —	20	120	178	210	242	295	395	495	595	695	795	895	/Lx	I	20
○—○	1	96	128	160	192	224	320	416	512	672	736	800	/Lx	— —	22

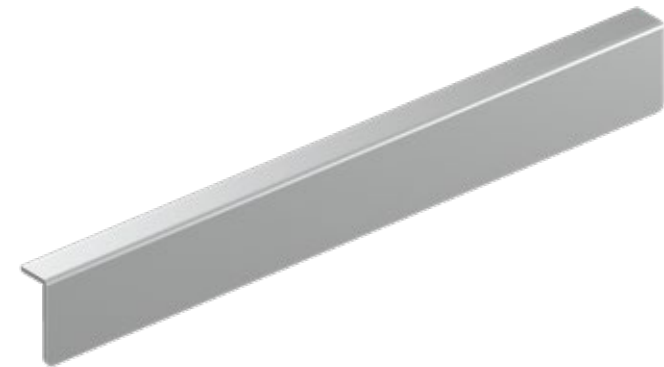

675.25

— —	60	147	197	247	297	347	397	447	497	547	597	697	797	897	997	1197	/Lx	I	25
○—○	32	32	See technical documentation / Pogledj tehnično dokumentacijo rujzdesign.com														/Lx	— —	11

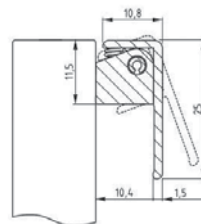

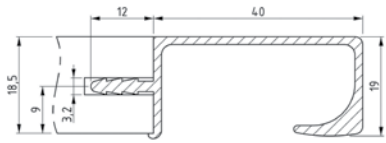

401.40 — 1833 2750 /Lx

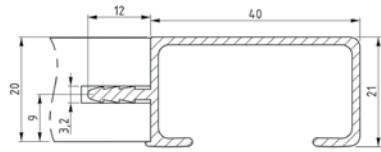

452.21 — 1833 2750 /Lx

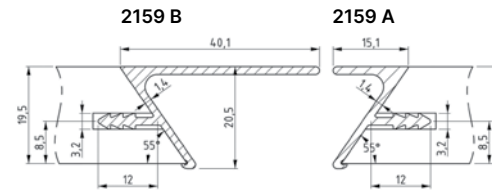

2159 A / B — 1833 2750 5500 /Lx

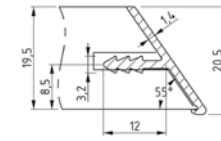

2197 — 1833 2750 5500 /Lx

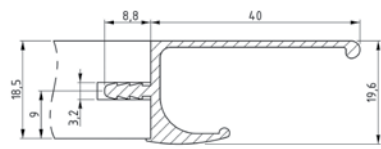

345.18 — 1833 2750 /Lx

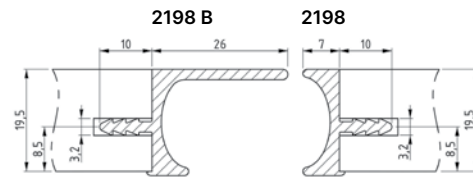

2198 / B — 1833 2750 /Lx

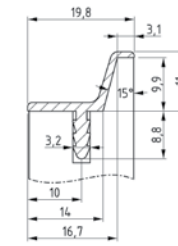

2159 D — 1833 2750 5500 /Lx

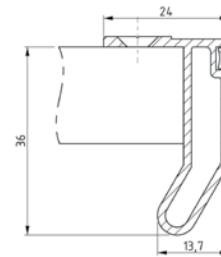

2107 — 1833 2750 /Lx

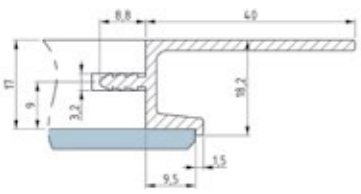

2139 — 1833 2750 /Lx

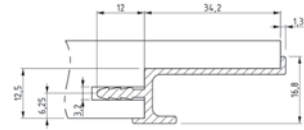

326.15 B — 1833 2750 /Lx

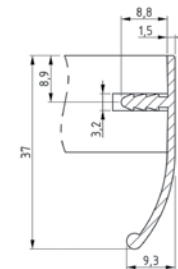

325.37 — 1833 2750 /Lx

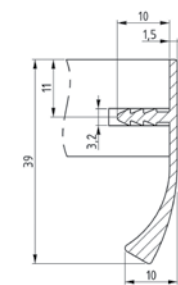

2192 — 1833 2750 /Lx

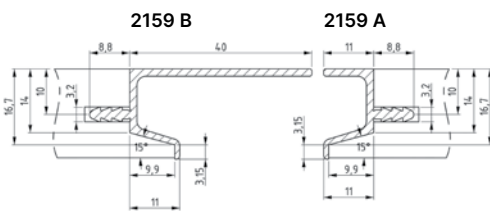

2159 A / B — 1833 2750 5500 /Lx

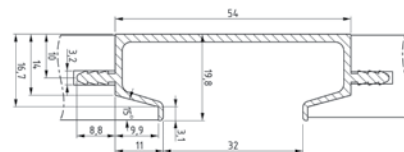

2159 C — 1833 2750 5500 /Lx

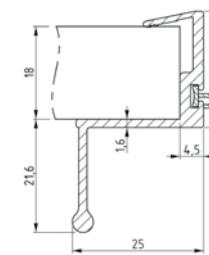

444.25 — 1833 2750 /Lx

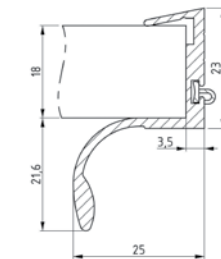

445.25 — 1833 2750 /Lx

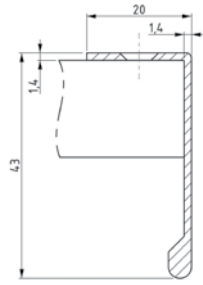

466.43 1833 2750 / Lx

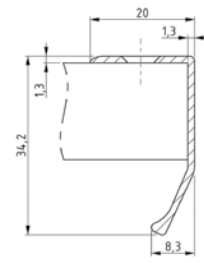

643.33 1833 2750 / Lx

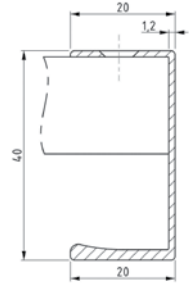

606.40 1833 2750 / Lx

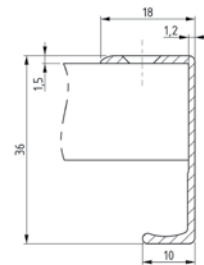

658.35 1833 2750 / Lx

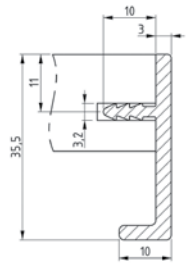

555.95 1833 2750 / Lx

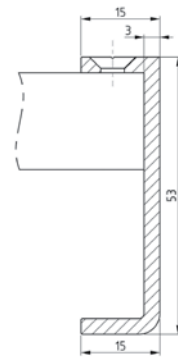

552.15 1833 2750 / Lx

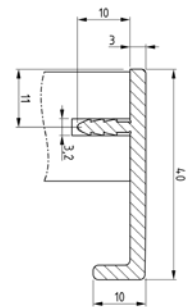

10.002 1833 2750 / Lx

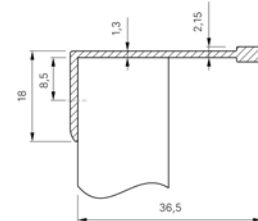

12.008 2750 5500 / Lx

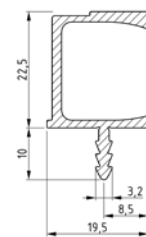

10.008 2750 5500 / Lx

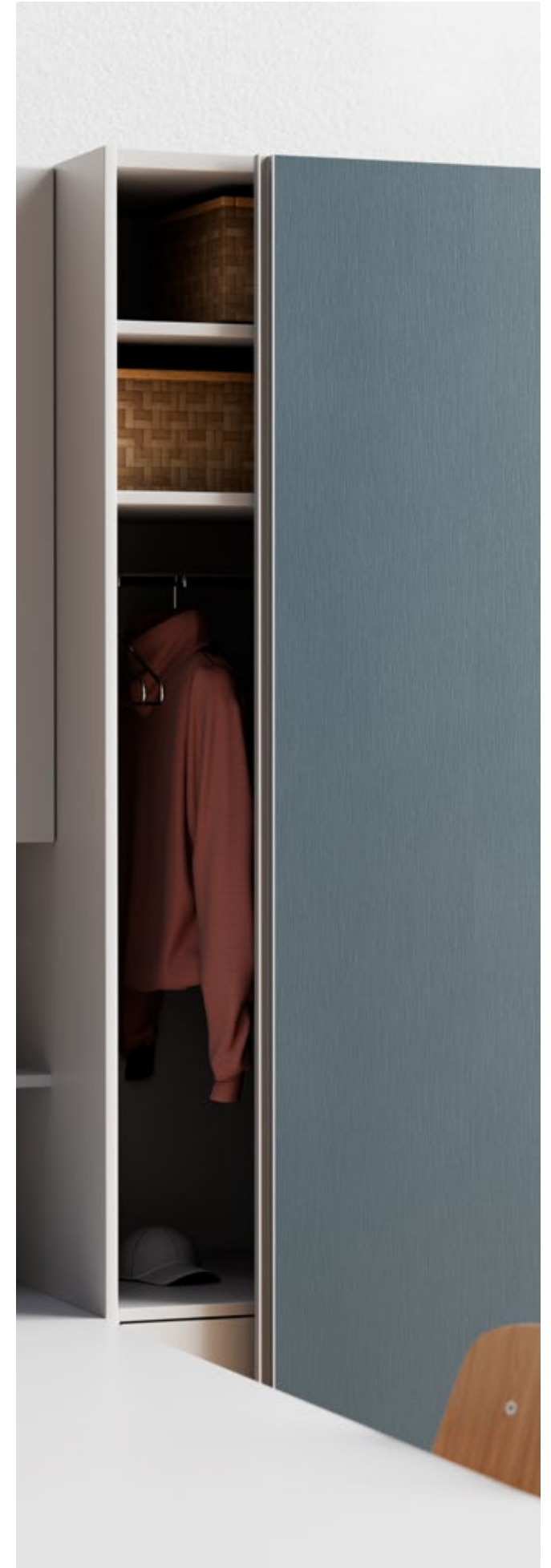



Long and wardrobe handles / Dolgi ročaji in ročajji za omare



723.18

723.18 B

723.13

723.13 B

723.18				
—	558	1102	2190	/ Lx
○—○	544	1088	2×1088	/ Lx
I	18			
⊥	44			
723.18 B				
—	558	1102	2190	/ Lx
○—○	544	1088	2×1088	/ Lx
I	18			
⊥	44			
723.13 B				
—	553	1097	/ Lx	
○—○	544	2×544	/ Lx	
I	13			
⊥	36			
723.13				
—	553	1097	/ Lx	
○—○	544	2×544	/ Lx	
I	13			
⊥	36			



684.12

665.12

697.14 B

697.14 C

684.12	—	1090	I	12
	○—○	864	↳	33
665.12	—	1090	I	12
	○—○	864	↳	33
697.14 B	—	1100	I	14
	○—○	2×540	↳	18
697.14 C	—	1100	I	14
	○—○	2×540	↳	18



708.15

525.27

709.16

693.20

708.15	—	1100	I	15
	○—○	2×448	↳	26
525.27	—	1100	I	7
	○—○	2×400	↳	27
709.16	—	1090	I	16
	○—○	2×400	↳	18
693.20	—	900	I	20
	○—○	770	↳	28

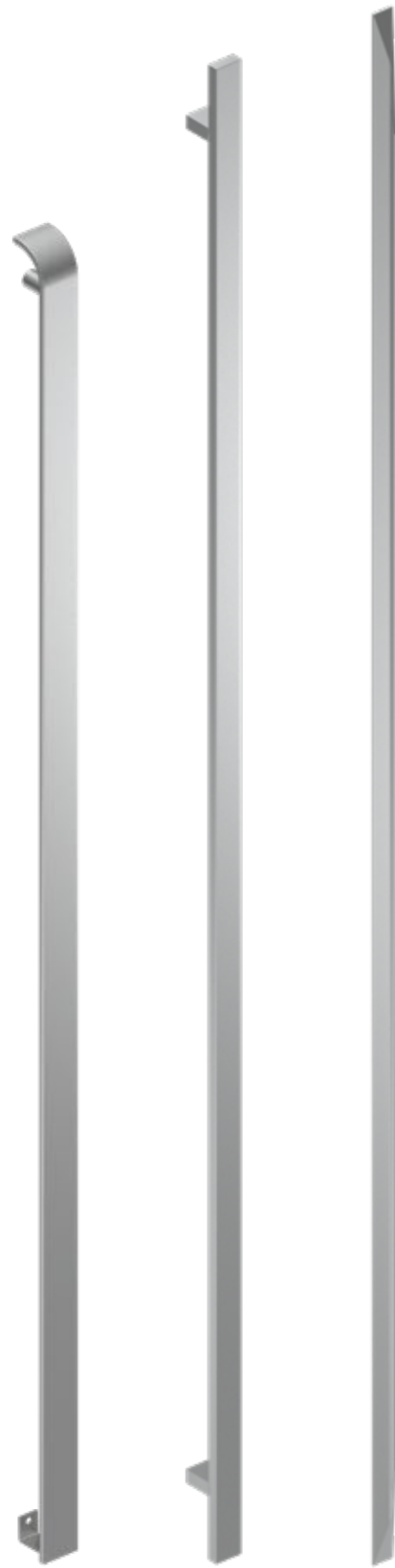

568.28

561.20

690.16

568.28	—	927	I	28
	○—○	882	┌	30
561.20	—	1060	I	20
	○—○	960	┌	29
690.16	—	1100	I	16
	○—○	2×352	┌	22



Integrated wardrobe handle / Vgradni ročaj za omare



326.15 L (D)

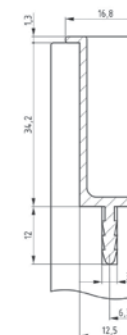

1090 / Lx

Curved handles / Ukrivljeni ročaji

520.20 C

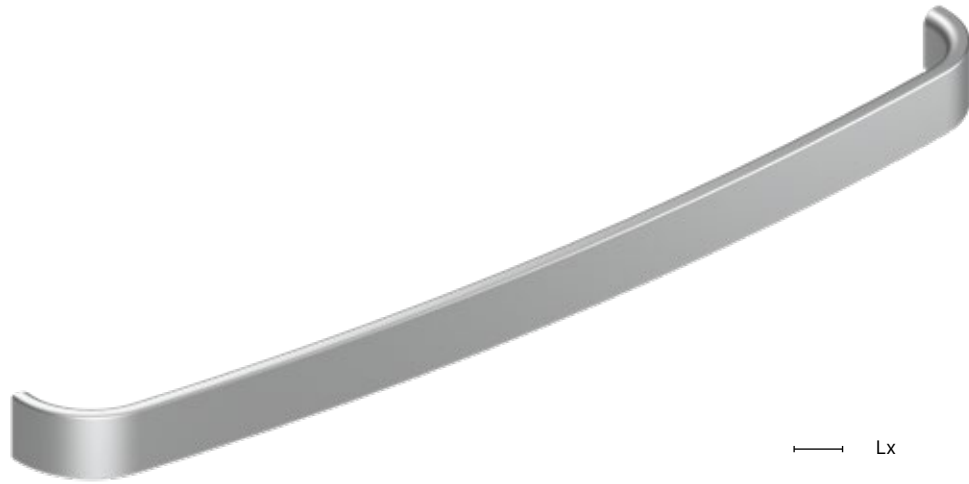

┌──┐	Lx	I	20
○──○	Lx	┌──┐	Lx

574.10 C

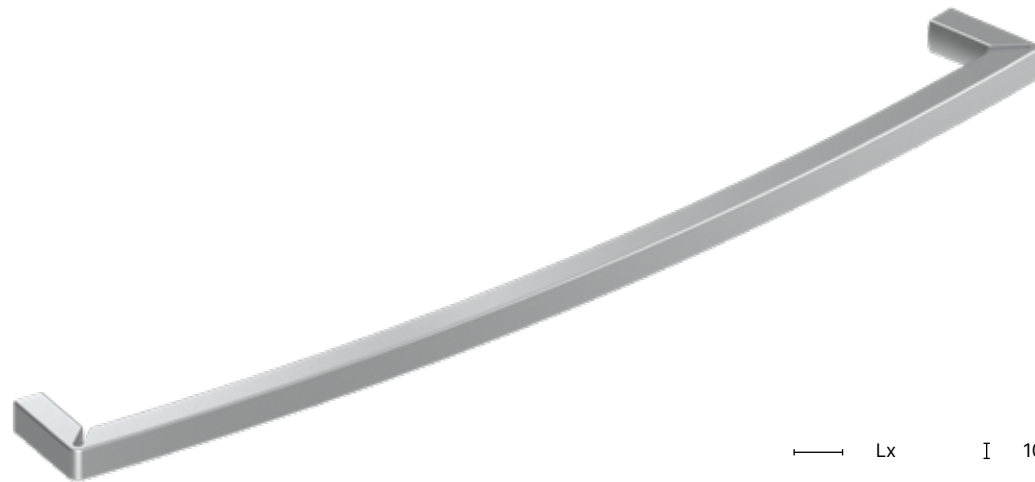

┌──┐	Lx	I	10
○──○	Lx	┌──┐	Lx

632.27 BC



┌──┐	Lx	I	7
○──○	Lx	┌──┐	Lx





Bathroom handles / Ročaji za kopalnice

2188



∅ fi 40 I 2×30

2189

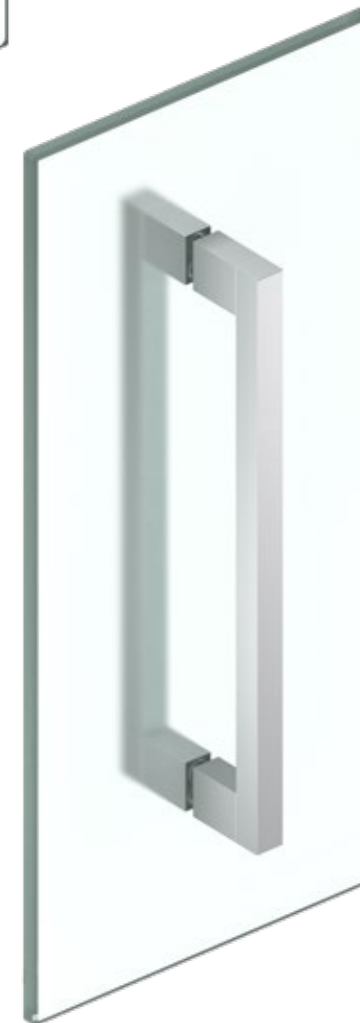

— 292 I 15
 ○—○ 256 ⇄ 2×45



616.08 — 41 I 8
 ○—○ 32



616.08 B — 41 I 8

13.005

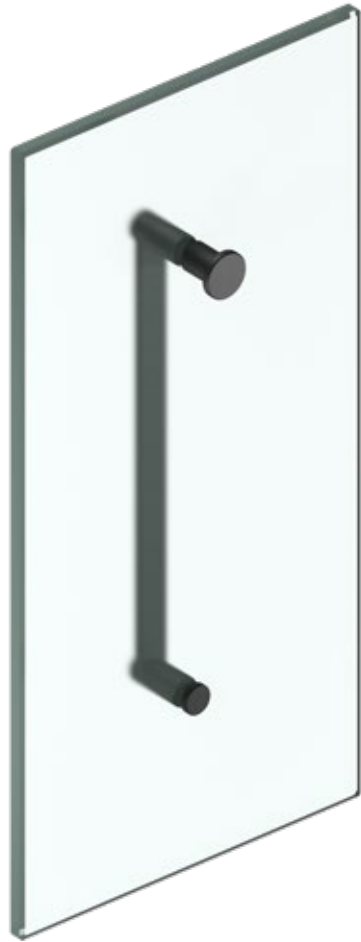

—	179	211	243	339	419	I	15 / 23
○—○	160	192	224	320	400	↳	31 / 24

13.006

—	175	207	239	335	415
○—○	160	192	224	320	400



I	15 / 15
↳	31 / 31

2109 A



—	211	307	403	499	595	819	1107	/Lx	I	16
○—○	160	256	352	448	544	768	1056	/Lx	↳	2×42

2144



—	208	I	16
○—○	192	↳	2×26



Integrated handles / Vsadni ročaji



555.95	—	145	195	245	295	345	395	445	495	545	595	695	795	895	995	1095	1195	/ Lx
555.97	—	147	197	247	297	347	397	447	497	547	597	697	797	897	997	1097	1197	/ Lx

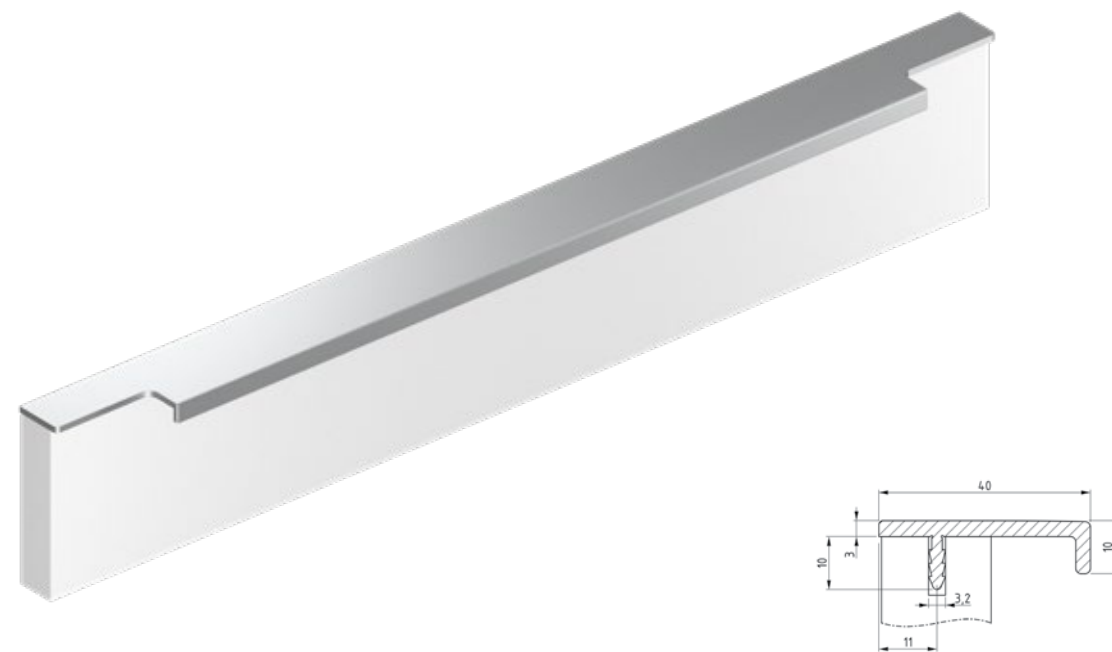

10.002	—	147	197	247	297	347	397	447	497	547	597	697	797	897	997	1097	1197	/ Lx
---------------	---	-----	-----	-----	-----	-----	-----	-----	-----	-----	-----	-----	-----	-----	-----	------	------	------

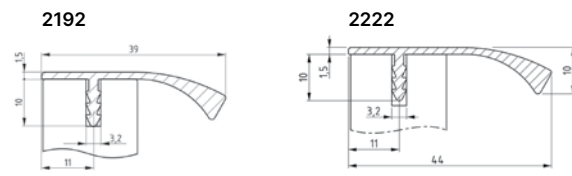
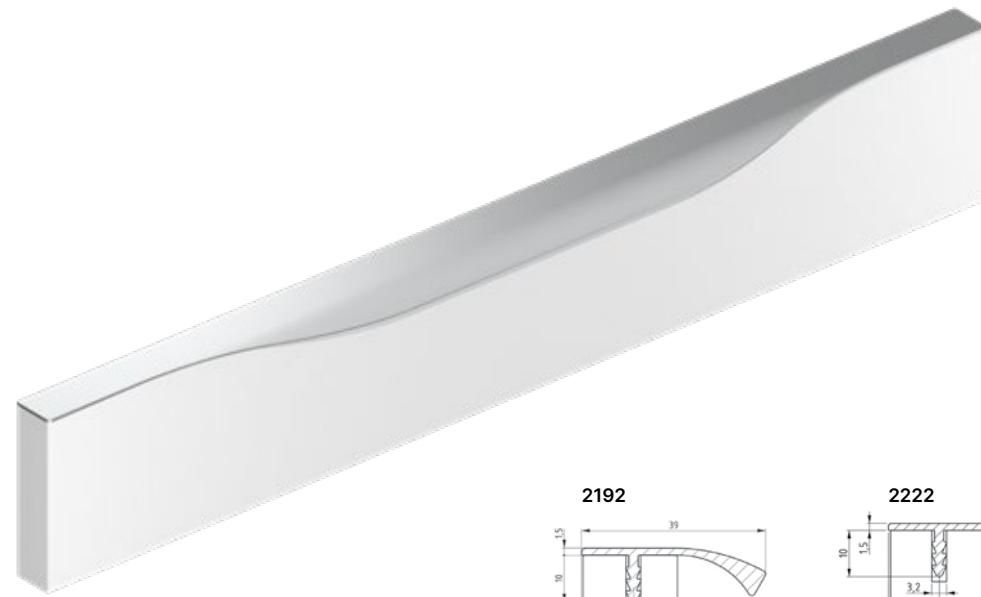

2192	—	147	197	247	297	347	397	447	497	547	597	697	797	897	997	1097	1197	/ Lx
2222	—	147	197	247	297	347	397	447	497	547	597	697	797	897	997	1097	1197	/ Lx

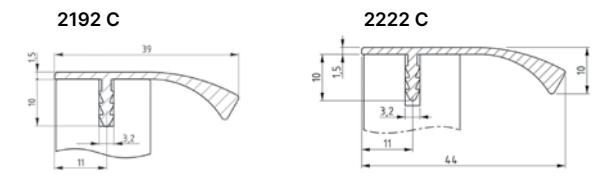

2192 C	—	147	197	247	297	347	397	447	497	547	597	697	797	897	997	1097	1197	/ Lx
2222 C	—	147	197	247	297	347	397	447	497	547	597	697	797	897	997	1097	1197	/ Lx

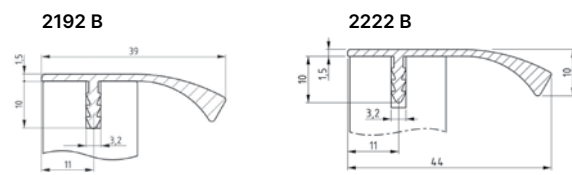

2192 B	—	147	197	247	297	347	397	447	497	547	597	697	797	897	997	1097	1197	/ Lx
2222 B	—	147	197	247	297	347	397	447	497	547	597	697	797	897	997	1097	1197	/ Lx

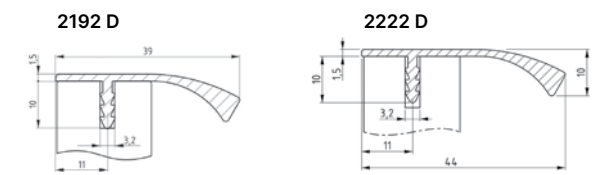
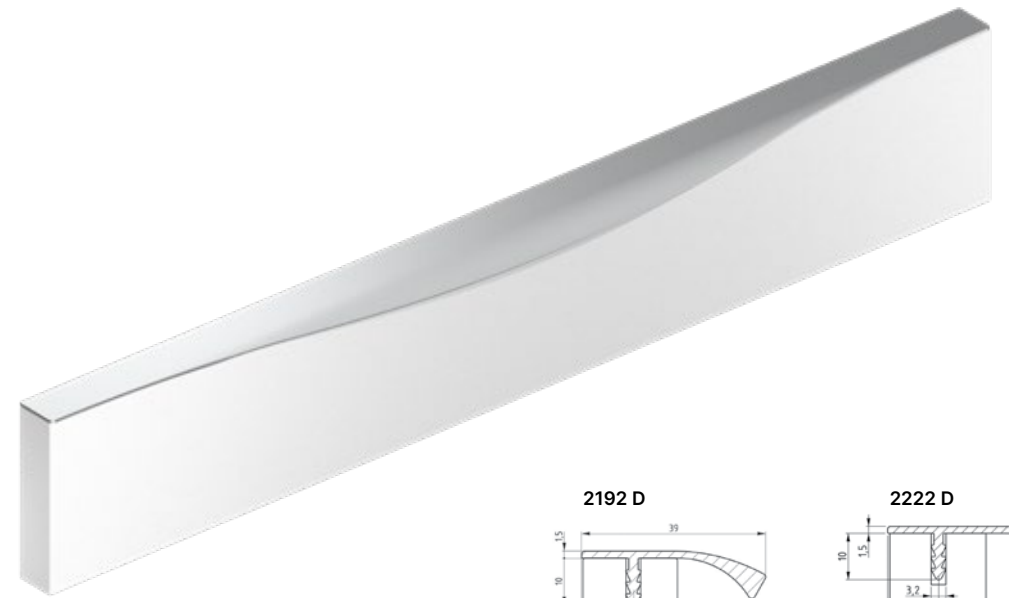

2192 D	—	147	197	247	297	347	397	447	497	547	597	697	797	897	997	1097	1197	/ Lx
2222 D	—	147	197	247	297	347	397	447	497	547	597	697	797	897	997	1097	1197	/ Lx

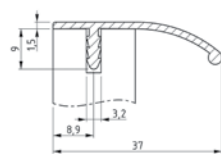

398.37 — 145 195 245 295 345 395 445 495 545 595 695 795 895 995 1095 1195 / Lx

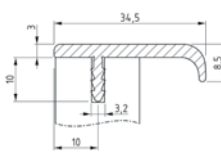

10.003 — 146 196 246 296 346 396 446 496 546 596 696 896 996 1196 / Lx

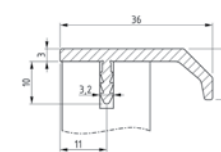

10.005 — 147 197 247 297 347 397 447 497 547 597 697 797 897 997 1197 / Lx

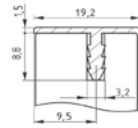

442.19

— 2750 / Lx
 — 2750 / Lx

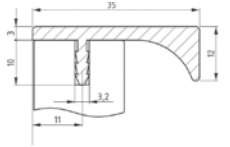

2217

— 146 196 246 296 346 396 446 496 546 596 696 796 896 996 1096 1196 / Lx

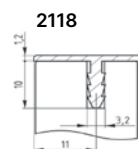
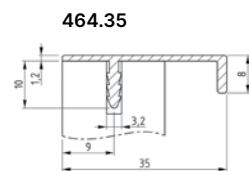
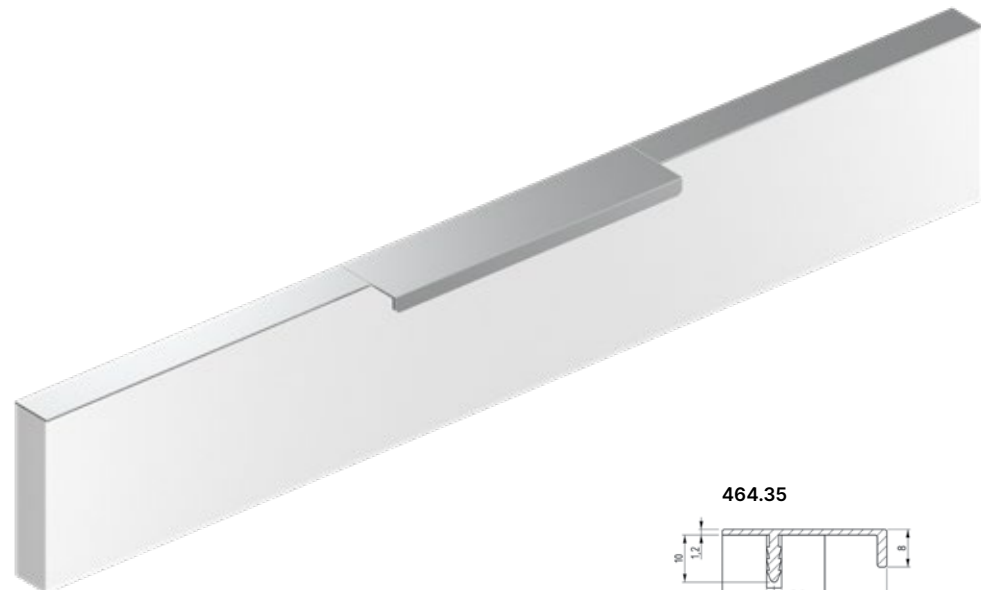

464.35

2118

— 152 452 1052 / Lx
 — 2750 / Lx

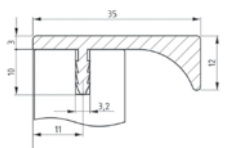

2141

— 147 197 247 297 347 397 447 497 547 597 697 797 897 997 1097 1197 / Lx

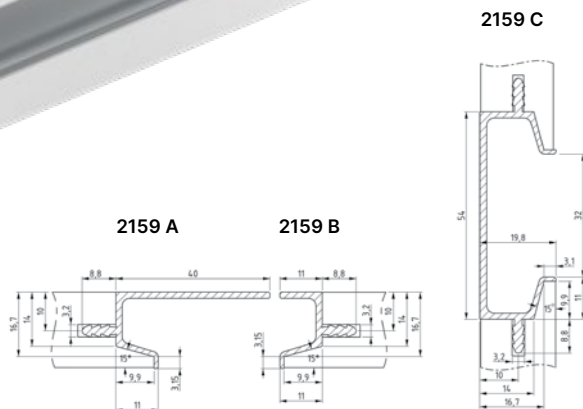

2159 A / B / C — 145 195 245 295 345 395 445 495 545 595 695 795 895 995 1095 1195 / Lx
 — 147 197 247 297 347 397 447 497 547 597 697 797 897 997 1097 1197 / Lx

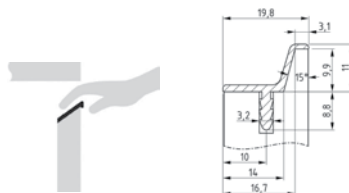
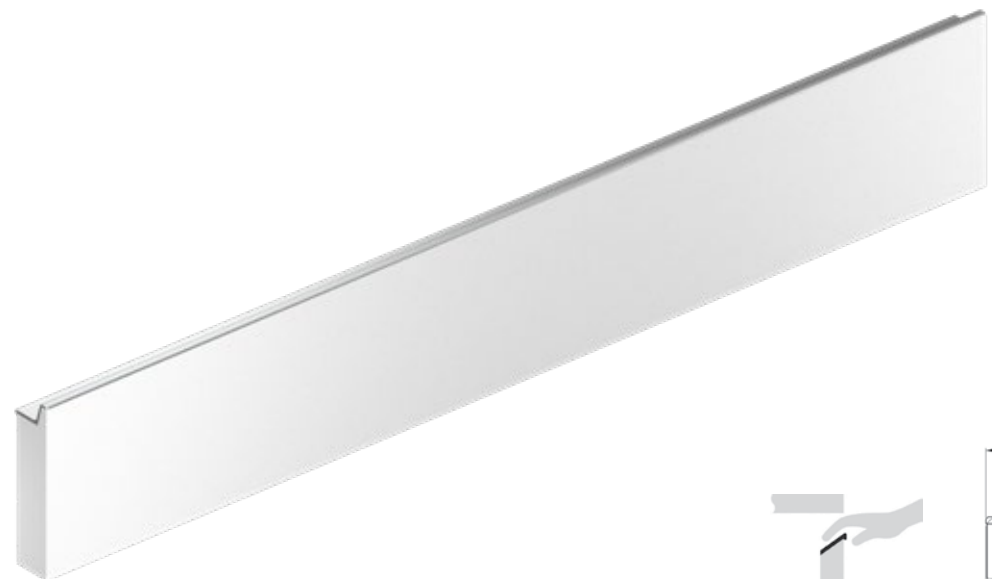

2159 D — 147 197 247 297 347 397 447 497 547 597 697 797 897 997 1197 / Lx

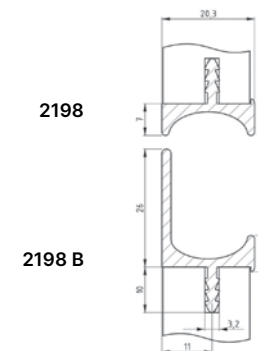

2198 / B — 147 197 247 297 347 397 447 497 547 597 697 797 897 997 1197 / Lx

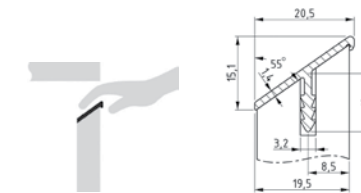
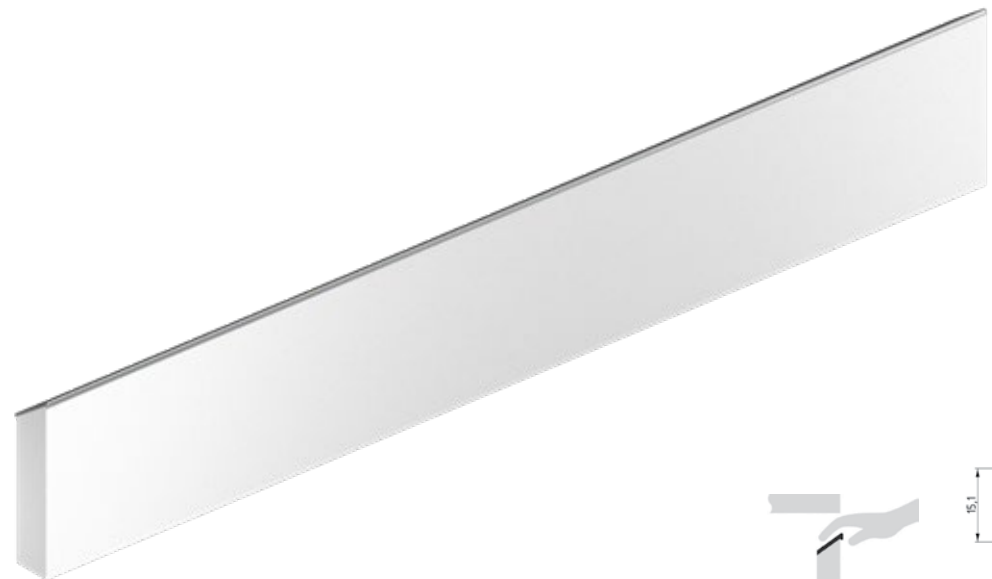

2197 — 147 197 247 297 347 397 447 497 547 597 697 797 897 997 1197 / Lx

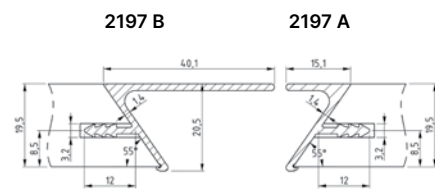
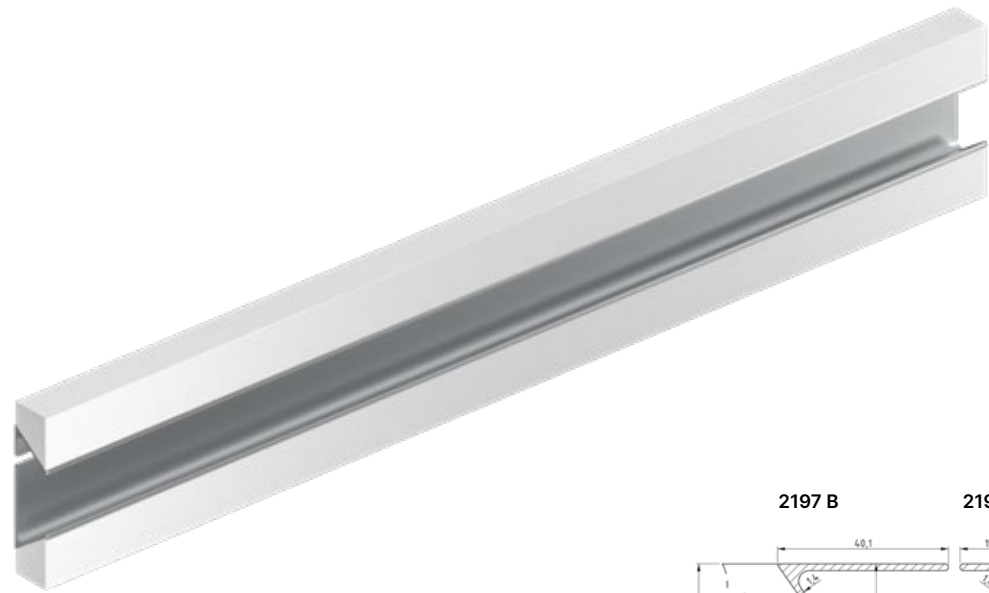

2197 A / B ——— 147 197 247 297 347 397 447 497 547 597 697 797 897 997 1197 / Lx

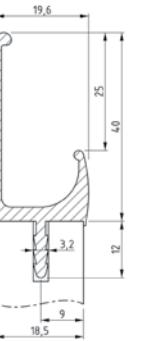

345.18 ——— 145 195 245 295 345 395 445 495 545 595 695 795 895 995 1195 / Lx

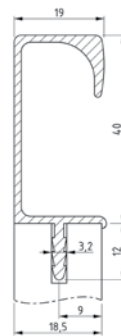

401.40 ——— 145 195 245 295 345 395 445 495 545 595 695 795 895 995 1095 1195 / Lx

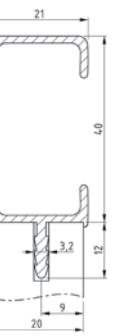

452.21 ——— 147 197 247 297 347 397 447 497 547 597 697 797 897 997 1097 1197 / Lx



441.97 — 147 197 247 297 347 397 447 497 547 597 697 797 897 997 1197 / Lx

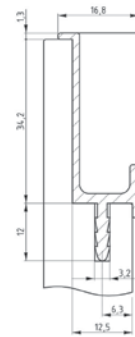

326.15 B — 145 195 245 295 345 395 445 495 545 595 695 795 895 995 1095 1195 / Lx

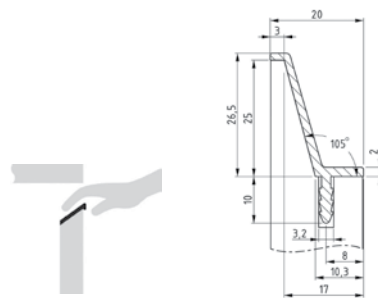
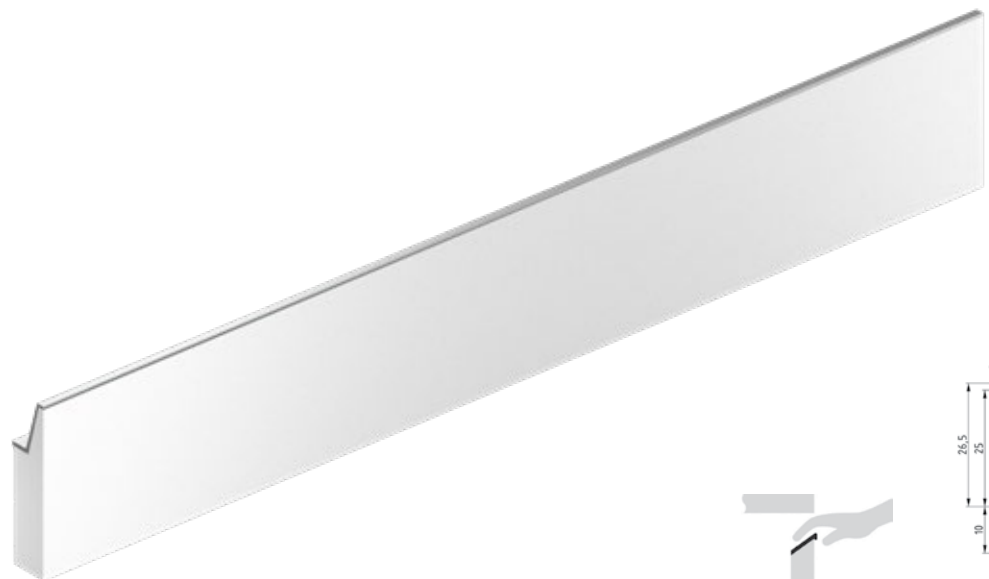

2142 — 146 196 246 296 346 396 446 496 546 596 696 796 896 996 1196 / Lx

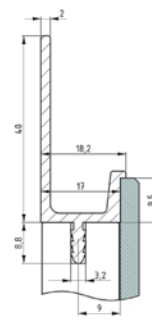

2139 — 146 196 246 296 346 396 446 496 546 596 696 796 896 996 1096 1196 / Lx

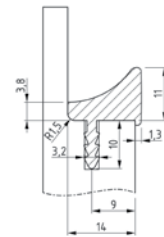

10.001 — 147 197 247 297 347 397 447 497 547 597 697 797 897 997 1097 1197 / Lx

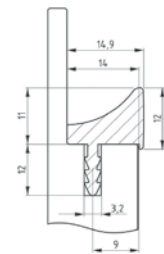

10.001 B — 100 200 350 / Lx



690.16 — 140 190 240 290 340 390 440 490 540 590 / Lx
 ○—○ 64 96 128 160 192 224 256 288 320 352 / Lx

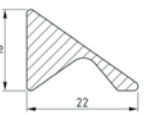
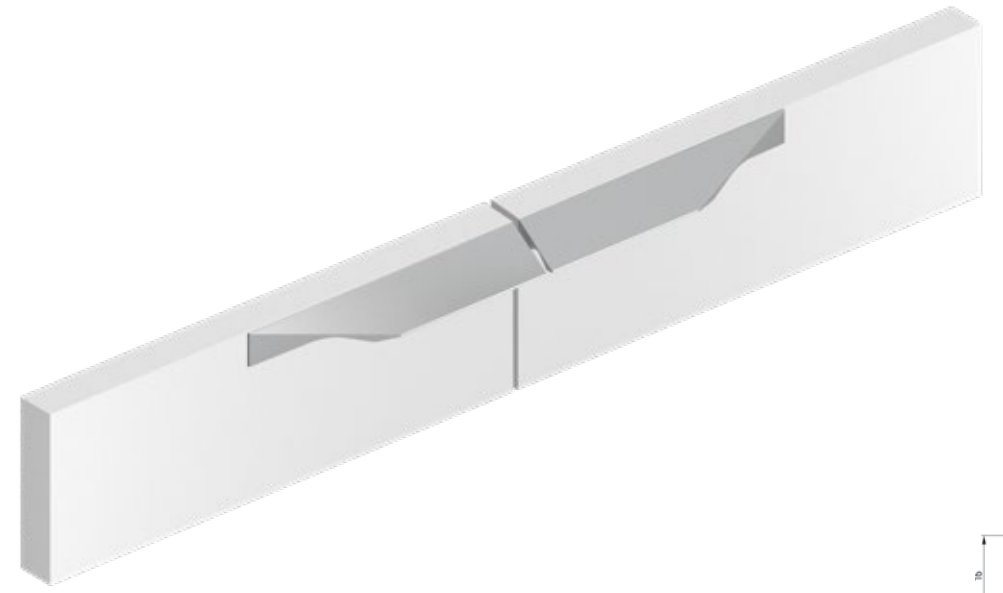

690.16 L (R) — 140 290 / Lx
 ○—○ 64 160 / Lx



697.14 B

—	116	150	200	250	300	350	400	450	500	/ Lx	I	14
○—○	96	128	160	224	280	320	380	430	480	/ Lx	⊢	18

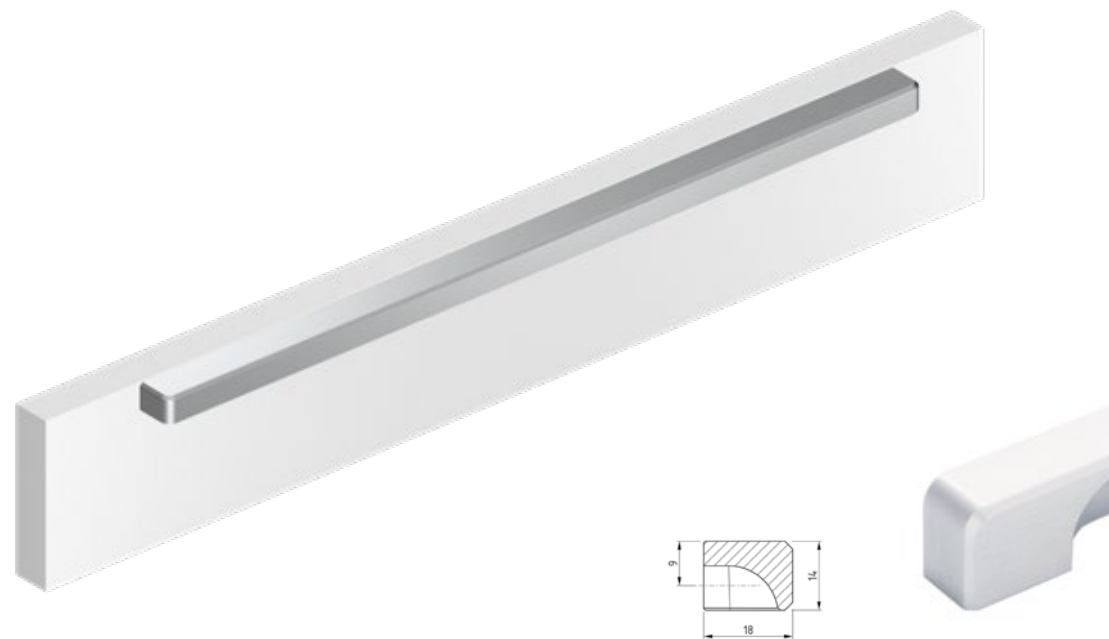

697.14 C

—	116	150	200	250	300	350	400	450	500	/ Lx	I	14
○—○	96	128	160	224	280	320	380	430	480	/ Lx	⊢	18



Backside screw handles / Ročaji za vijačenje zadaj

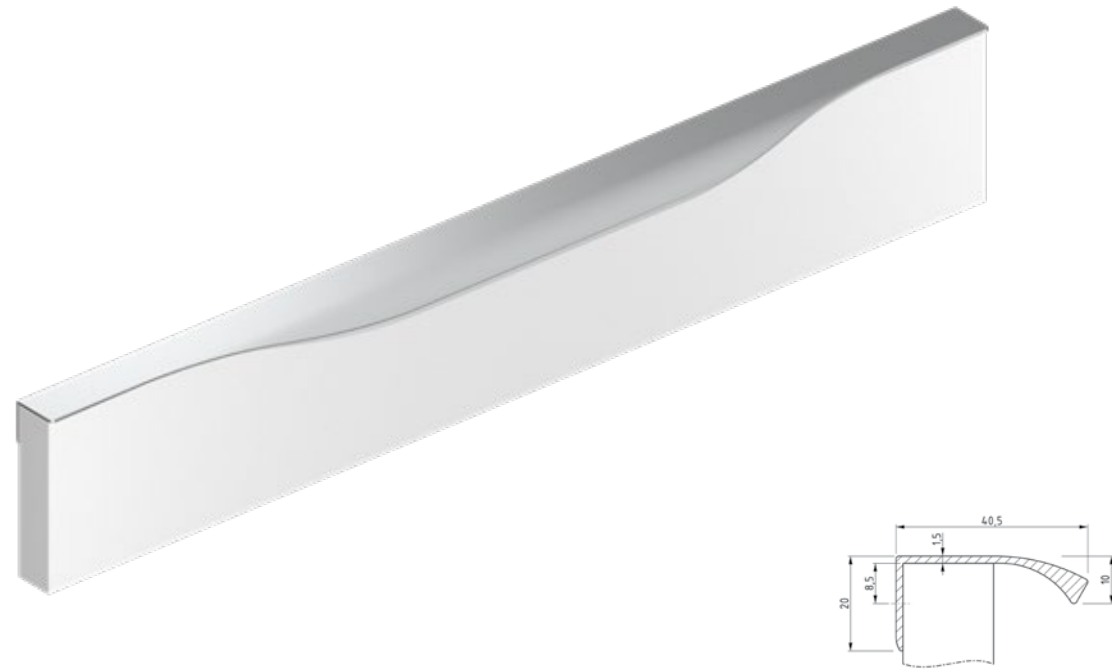

12.002 A

—	147	197	247	297	347	397	447	497	547	597	697	797	897	997	1197	/ Lx
○—○	64	128	192	192	224	288	320	2×192	2×224	2×256	2×288	3×224	3×256	3×288	3×352	/ Lx



12.002 B

—	147	197	247	297	347	397	447	497	547	597	697	797	897	997	1197	/ Lx
○—○	64	128	192	192	224	288	320	2×192	2×224	2×256	2×288	3×224	3×256	3×288	3×352	/ Lx

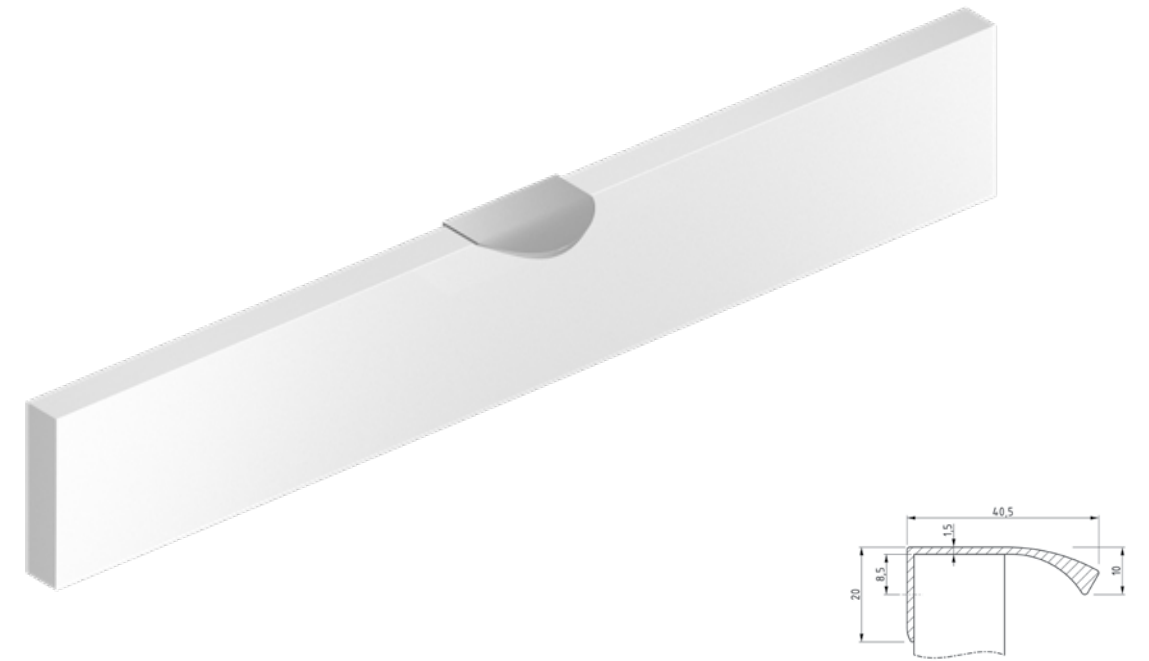

12.002 F

—	60	80	120	/ Lx
○—○	32	64	96	/ Lx



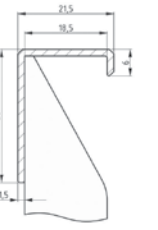

609.18

—	147	247	297	347	397	447	497	597	797	897	997	1097	1197	/ Lx
○—○	100	190	220	250	250	220/400	220/450	220/540	220/720	220/800	200/900	220/1000	220/1000	/ Lx

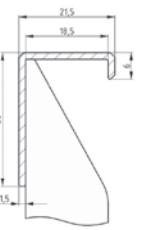

609.18 D

—	170	270	470	/ Lx
○—○	150	250	450	/ Lx



656.35

— 147 197 247 297 347 397 447 497 597 697 797 897 997 1097 1197 / Lx
 ○—○ 100 140 190 220 260 300 2×195 2×220 2×260 2×300 3×240 3×270 3×290 3×320 3×350 / Lx



643.33

— 45 90 160 200 / Lx
 ○—○ 16 64 128 160 / Lx

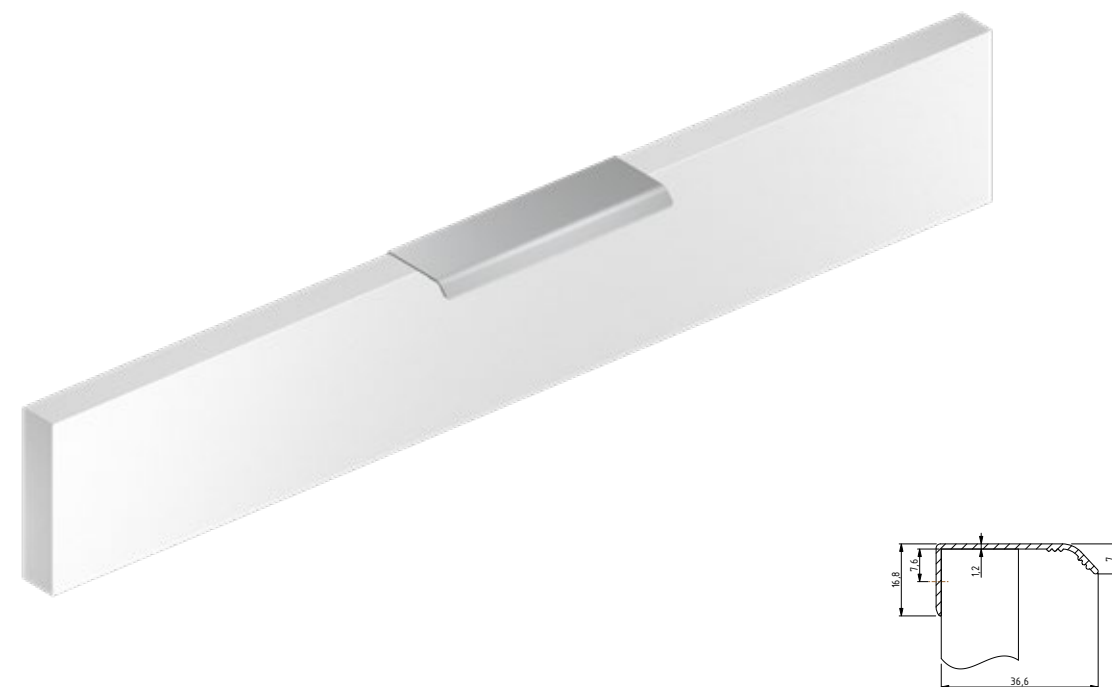

12.003

— 120 / Lx
 ○—○ 96 / Lx



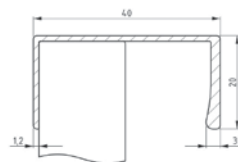
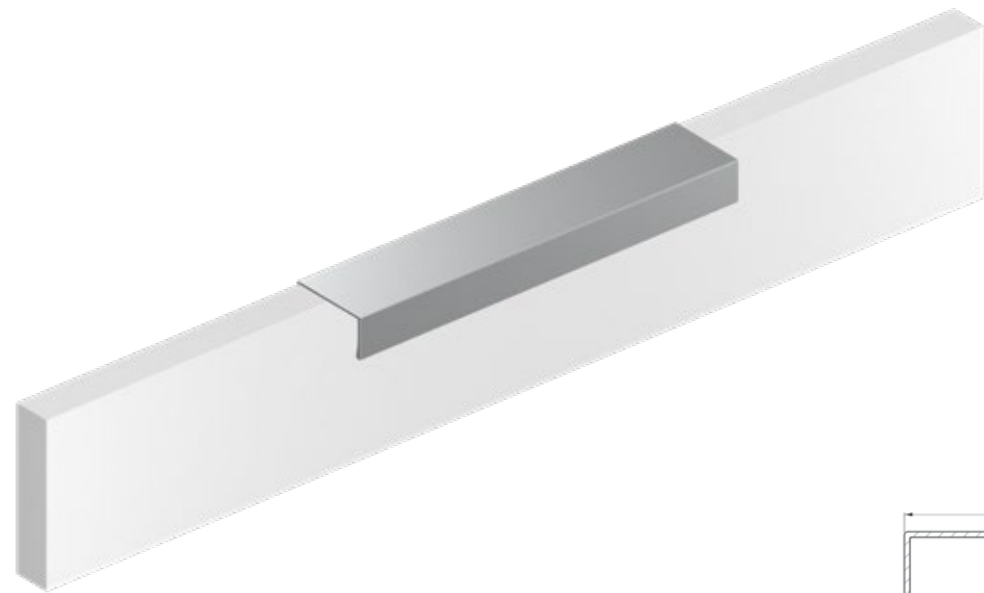

606.40

— 50 200 350 500 / Lx
 ○—○ 32 160 288 2×224 / Lx

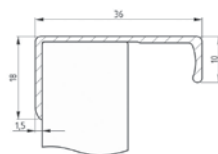

658.35

— 50 90 200 / Lx
 ○—○ 32 64 160 / Lx

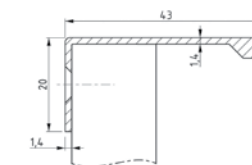

466.43

— 40 200 400 / Lx
 ○—○ 32 128 295 / Lx

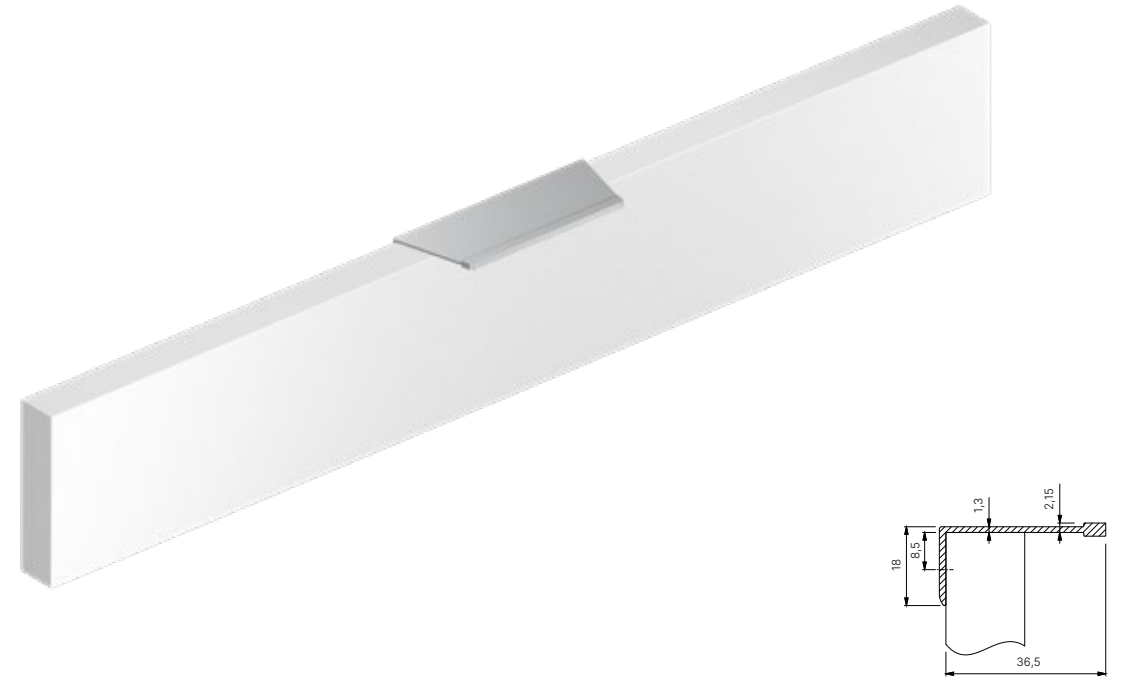

12.008 B

— 50 100 / Lx
 ○—○ 32 64 / Lx



12.008

— 147 197 247 297 347 397 447 497 547 597 697 797 897 997 1197 / Lx
 ○—○ 96 128 192 192 224 2×160 2×192 2×192 2×224 2×256 3×192 3×224 3×256 3×288 4×288 / Lx



Embedded handles / Utopni ročaji



455.18

— 164 264 314 364 464 / Lx



326.15

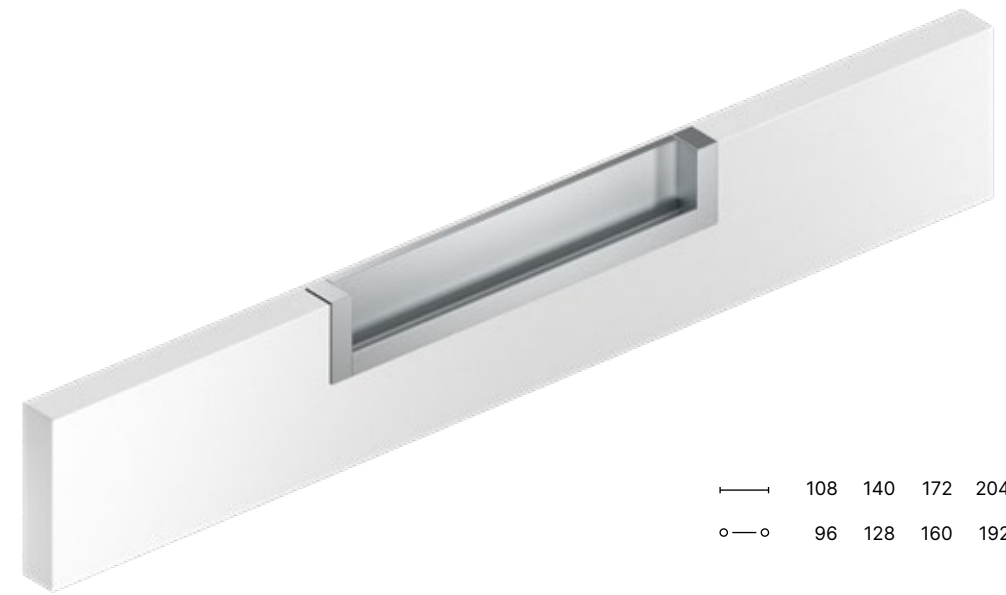

— 108 140 172 204 236 / Lx
 ○—○ 96 128 160 192 224 / Lx



326.15 L + 326.15 D

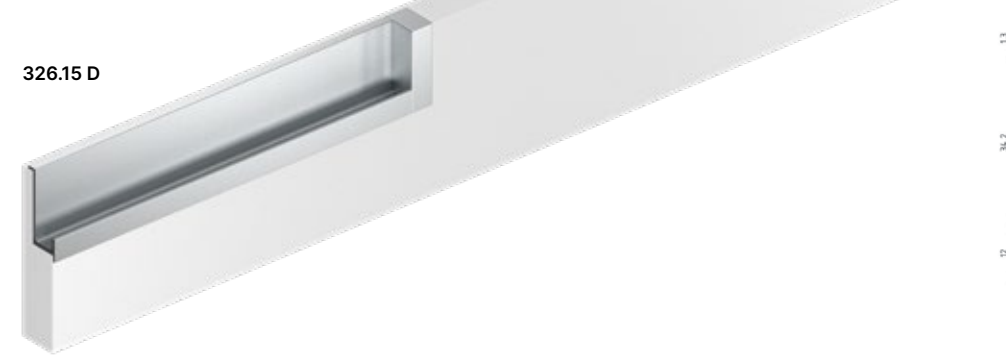

326.15 D

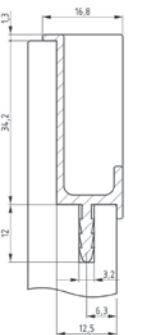

326.15 L (D)

— 1090 / Lx

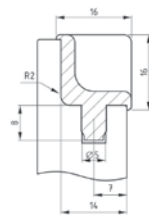

U11/14

— 298
 ○—○ 2×128

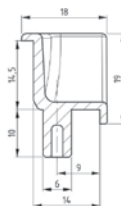
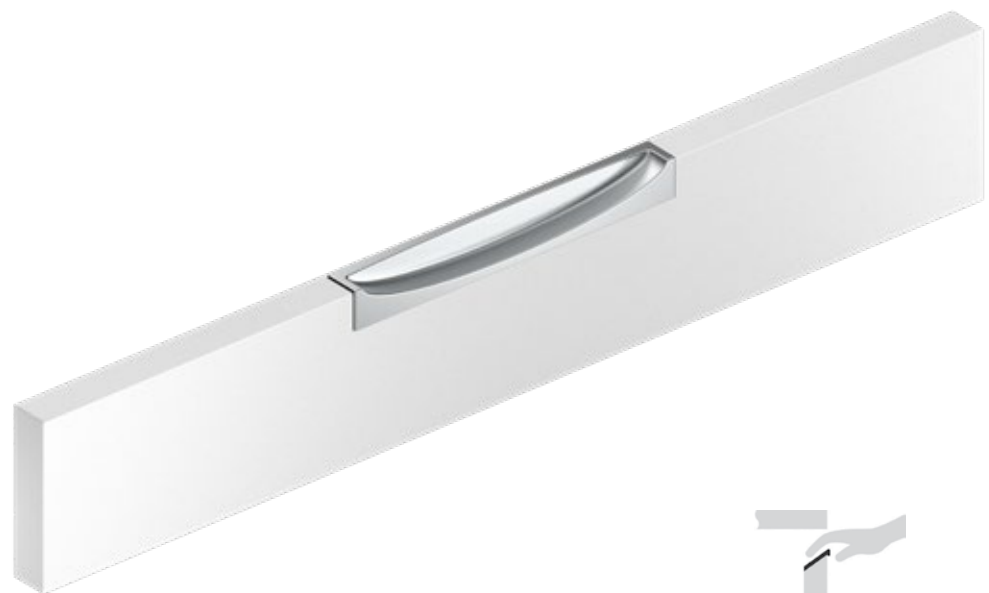

586.14

— 170
 ○—○ 96

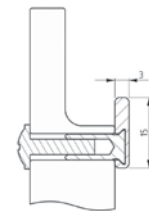

674.15

— 197 247 297 347 397 447 497 597 697 797 897 997 1097 1197 / Lx
 ○—○ 120 2×85 2×110 2×135 2×160 2×185 2×210 4×130 4×155 4×180 4×205 4×230 4×255 4×280 / Lx

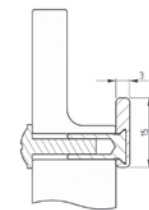

674.15 B

— 101 197 347 / Lx
 ○—○ 64 2×80 2×160 / Lx

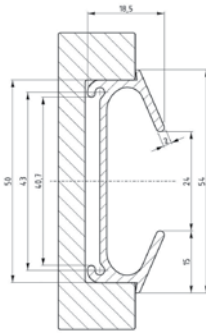

403.07

— 147 179 211 243 275 / Lx I 54
 ○—○ 128 160 192 224 256 / Lx H 12+7

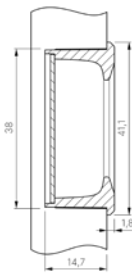

U11.003

— 203 I 41
 ○—○ 192 H 15+2



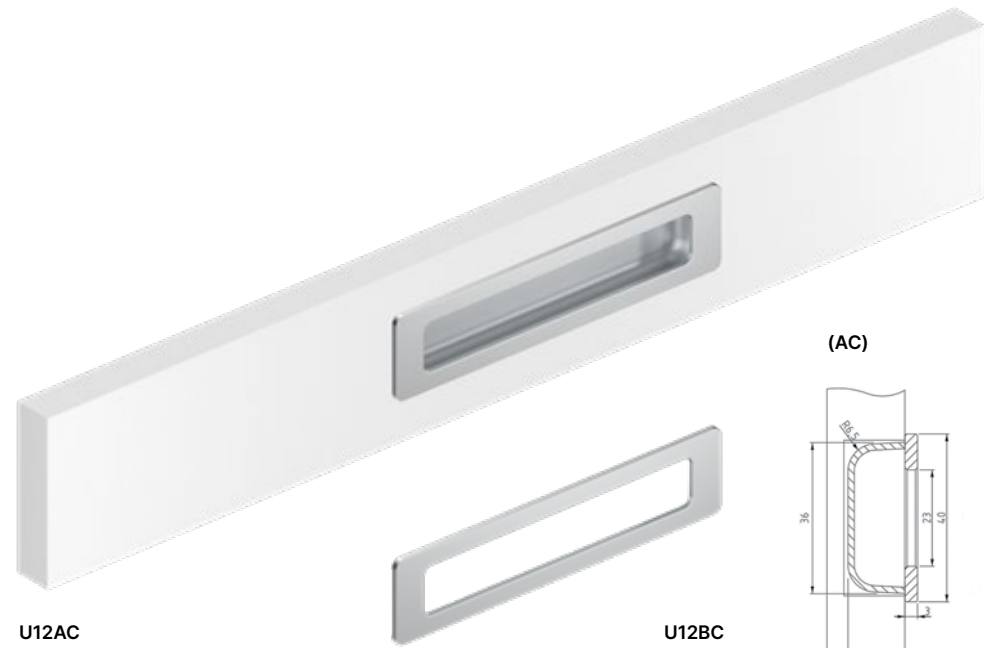

U12AC



U12BC

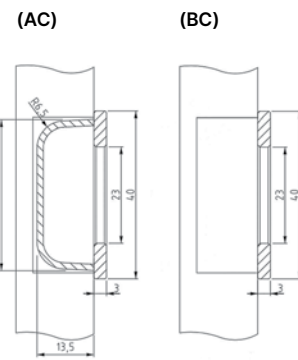

U12AC (BC)

—	108	172	I	40
○—○	96	160	↳	14+3

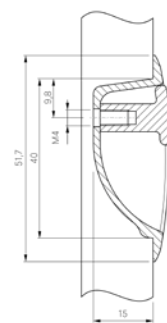

U7.180/40

—	192	I	52
○—○	160	↳	15+5

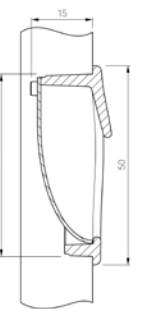

U6.56/45

—	61	I	50
○—○	32	↳	16+5

U6.137/45

—	142	I	50
○—○	128	↳	16+5



U9.41/41
 — 41 I 41
 ○—○ 28 H 14+2

U9.175/55
 — 175 I 55
 ○—○ 160 H 14+2



U11.001/35
 ∅ f35 I 42
 H 14+2

U11.001/50
 ∅ f50 I 55
 H 14+2





Gola - horizontal profiles / horizontalni profili

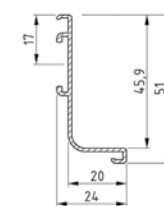
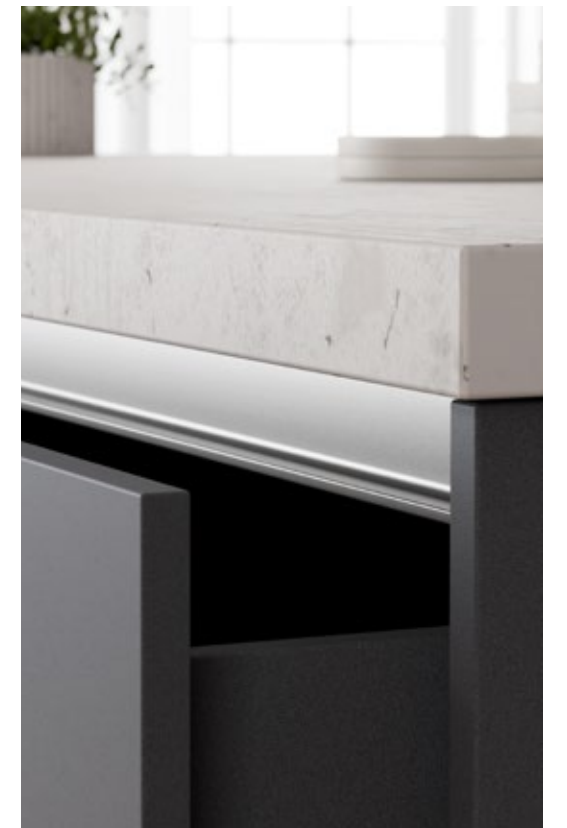
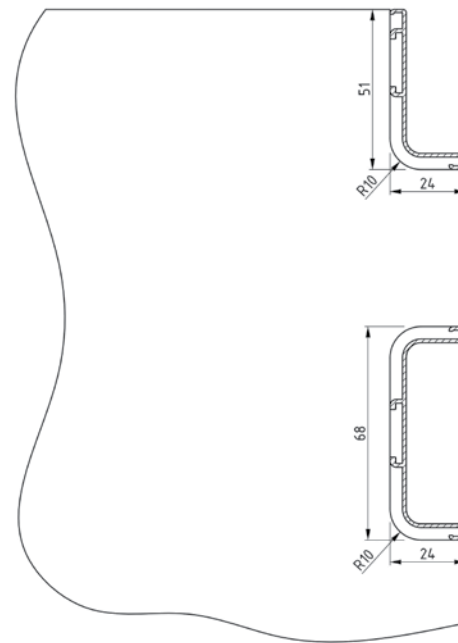

2199 L

2750 5500 / Lx

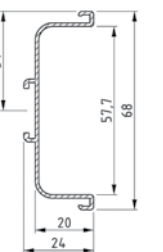

2199 C

2750 5500 / Lx

Gola - fitting systems / montažni sistemi

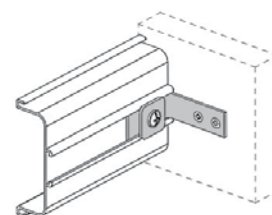

2199 K

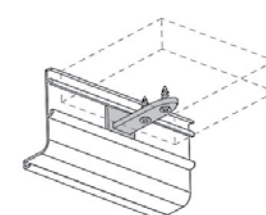

2199 T-18 / T-19

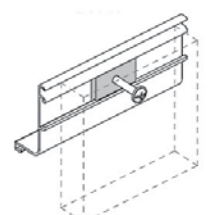

2199 P

Gola - vertical profiles / vertikalni profili

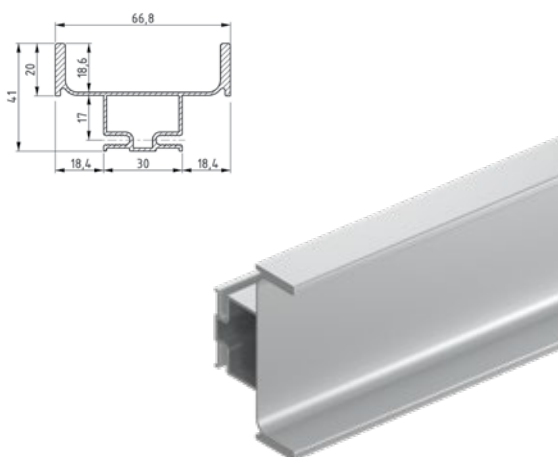
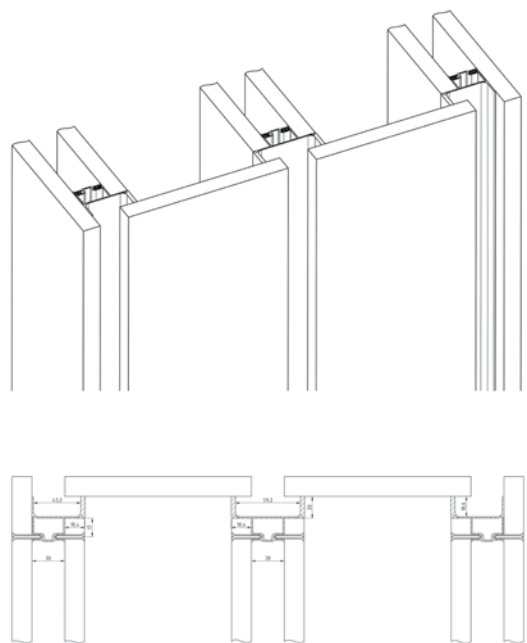

2200 C 2250 4500 / Lx

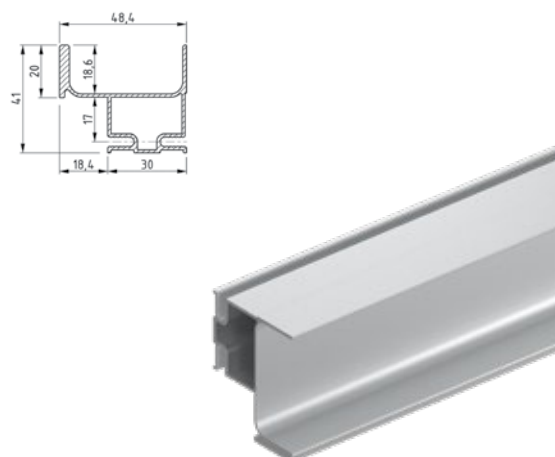

2200 L 2250 4500 / Lx

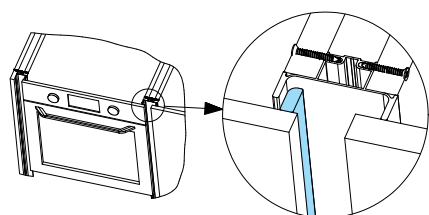

2200 P



1210 / Lx

Gola - caps / zaključki

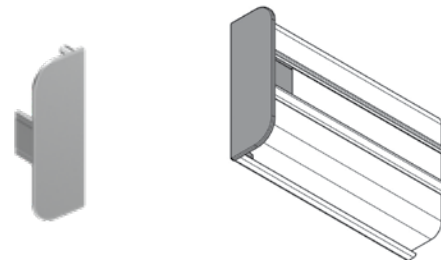

2199 C.F

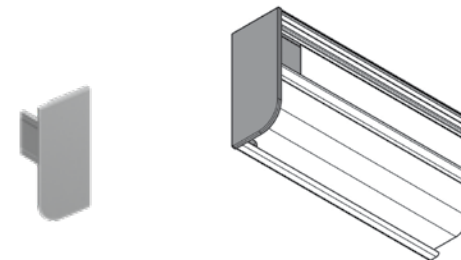

2199 L.F

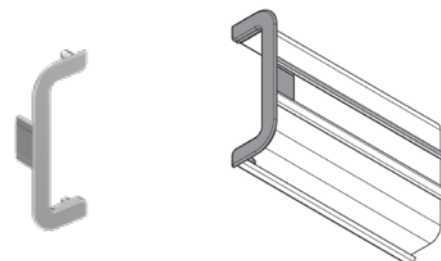

2199 C.E

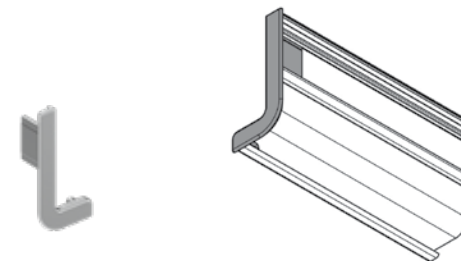

2199 L.E

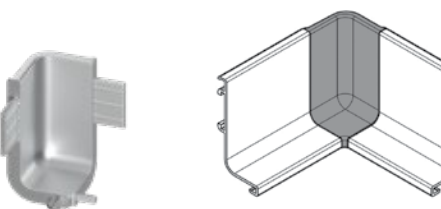

2199 L.I

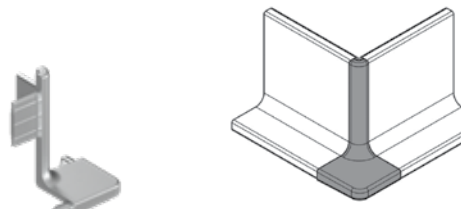

2199 L.O

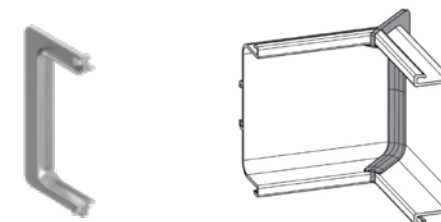

2199 C.IS

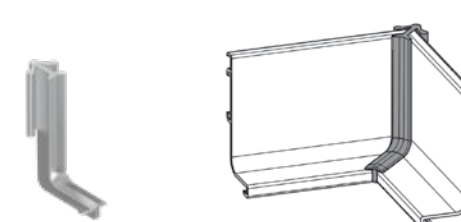

2199 L.IS

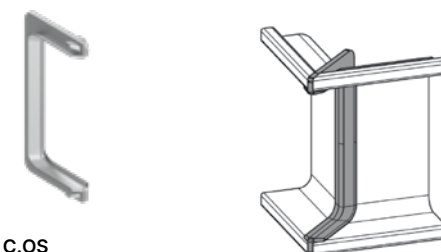

2199 C.OS

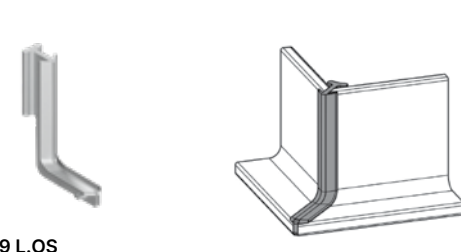

2199 L.OS



Luggage rack bars / Zaščitni drsniki

80.001

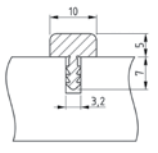
— 300 350 400 450 500 600 700 / Lx

80.002

— 300 350 400 450 500 600 700 / Lx
 ○—○ 200 250 300 350 400 2×224 2×256 / Lx

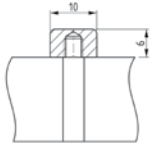
80.003

— 300 350 400 450 500 600 700 / Lx

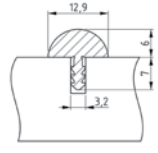
Copper / Baker

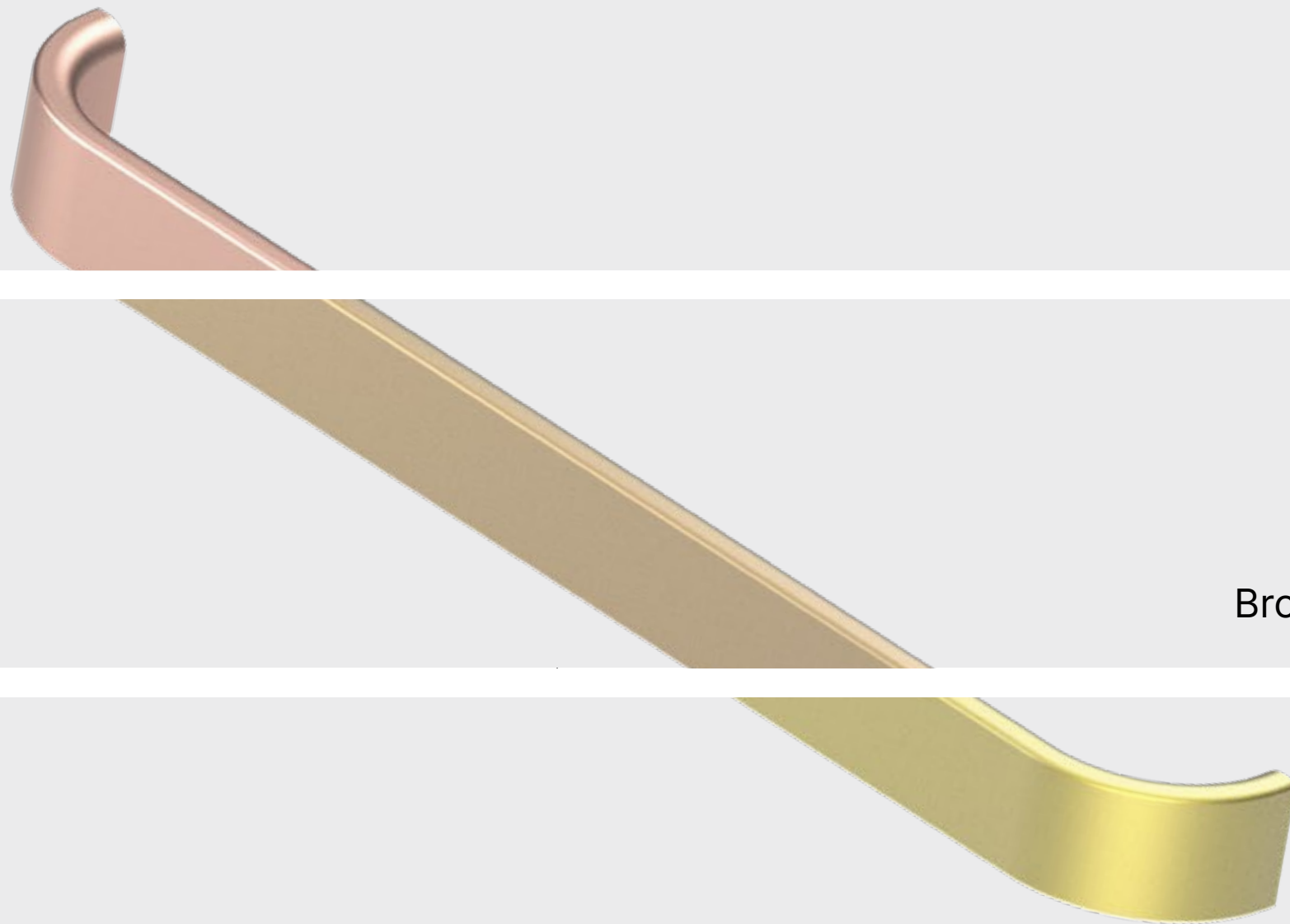

Bronze / Bron

Gold / Zlata

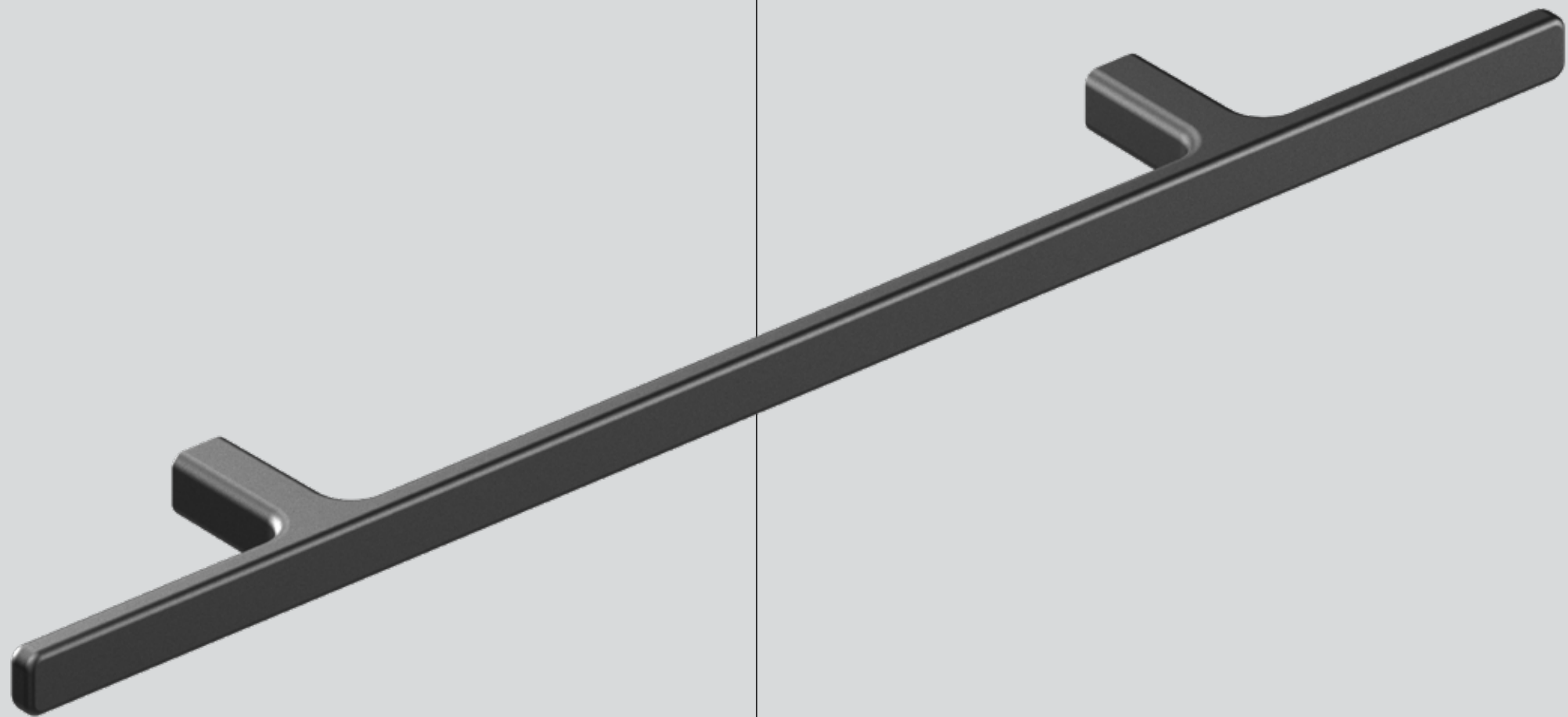

Metal handles and knobs

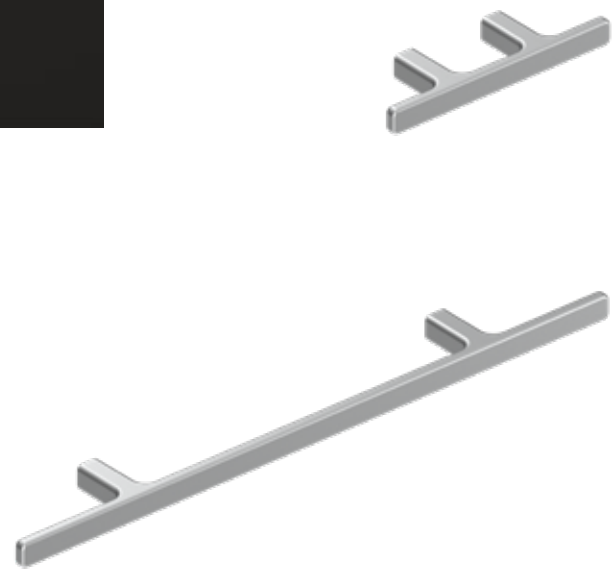

720.08

—	80	216	I	8
○—○	32	128	↳	24



719.26

—	63	232	I	29
o—o	16	192	H	25

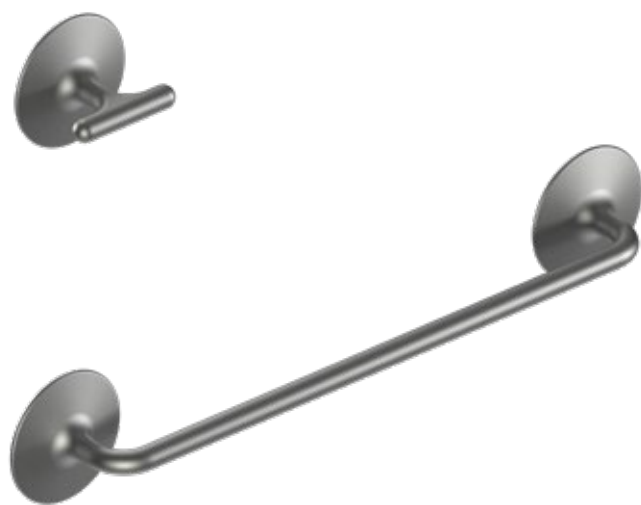

718.07

—	40	232	I	40
o—o	1	192	H	28



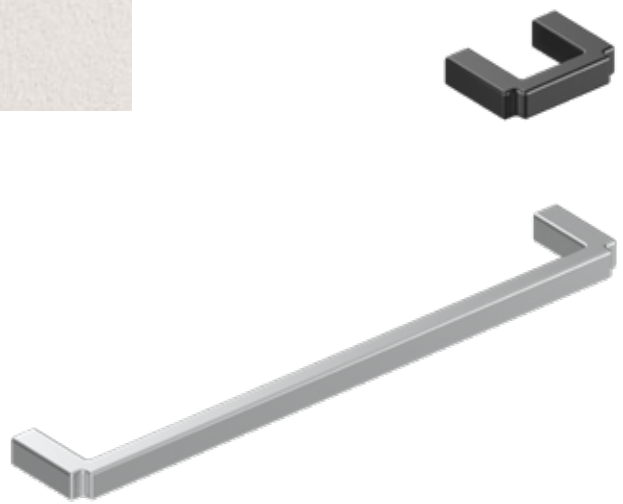

722.09

—	41	201	297	I	9
○—○	32	192	288	↳	27



587.25

— 170 234 I 15
 ○—○ 160 224 H 25

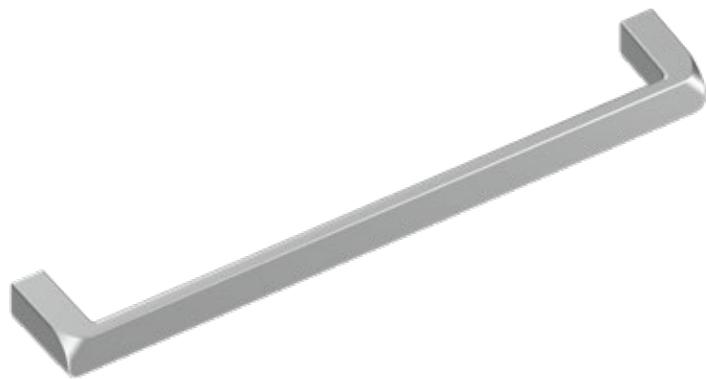

588.25

— 172 236 I 21
 ○—○ 160 224 H 25



703.14

— 185 249 345 I 14
 ○—○ 160 224 320 H 27



529.27

— 113 150 190 222 286 I 9
 ○—○ 96 128 160 192 256 H 27

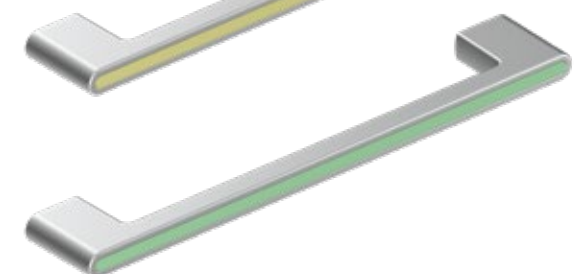
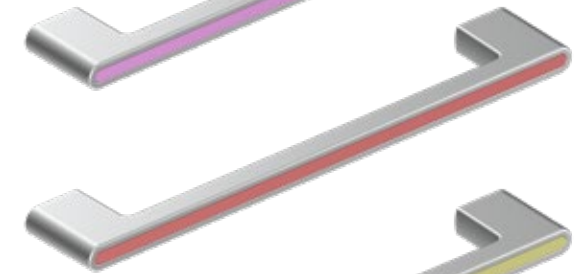
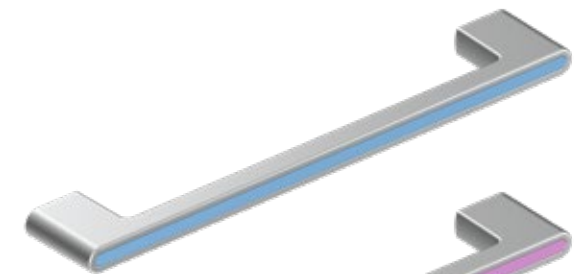

677.08

— 178 I 9
 ○—○ 160 H 28



700.14



—	200	264	360	I	14
○—○	160	224	320	↳	18

689.14

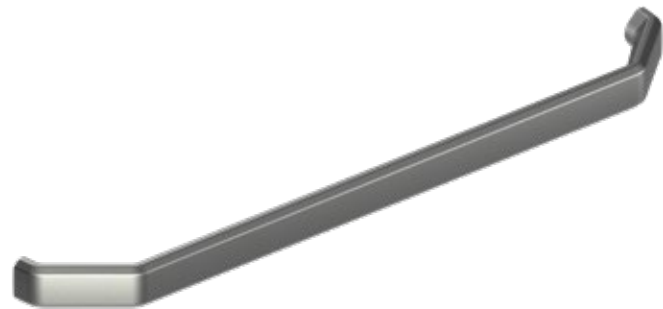

—	170	234		I	14
○—○	160	224		↳	28

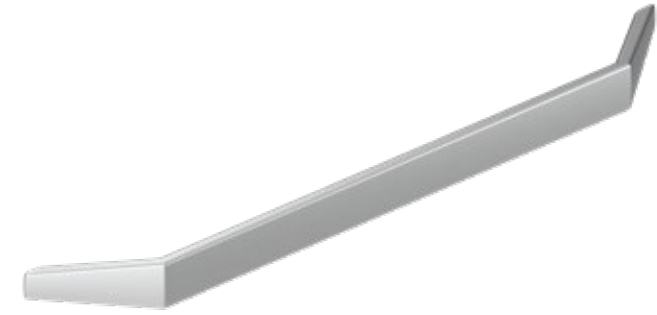

669.15

—	168	232	328	I	15
○—○	160	224	320	↳	26



694.16

—	186	250		I	16
○—○	160	224		↳	27

696.15



—	168	232		I	15
○—○	160	224		↳	27

668.15



┌──┐	218	282	I	15
○─○	160	224	┌─┐	29

580.26



┌──┐	172	236	I	14
○─○	160	224	┌─┐	26



836.26

┌──┐	18		I	14
			┌─┐	26

667.20



┌──┐	198		I	20
○─○	128		┌─┐	29

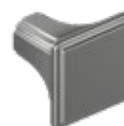

667.20

┌──┐	28		I	28
			┌─┐	29

498.16



┌──┐	144	208	I	16
○─○	128	192	┌─┐	26

536.16



┌──┐	144	208	I	16
○─○	128	192	┌─┐	26



527.13

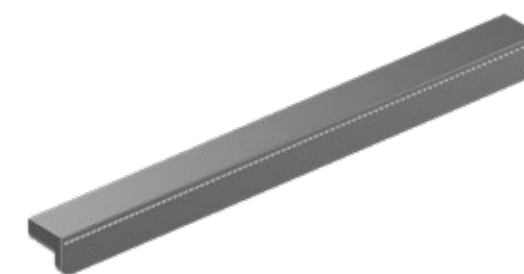

527.13 B

527.13 / B

┌──┐	80	176	I	13
○─○	64	128	┌─┐	15

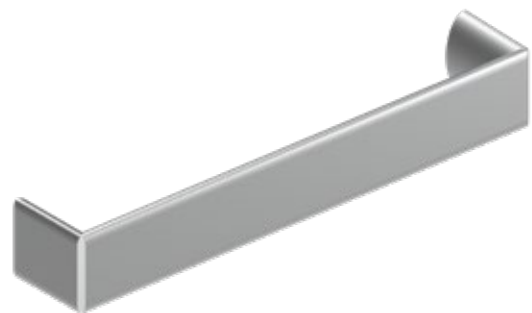

495.25

—	167	I	25
○—○	160	┌	29

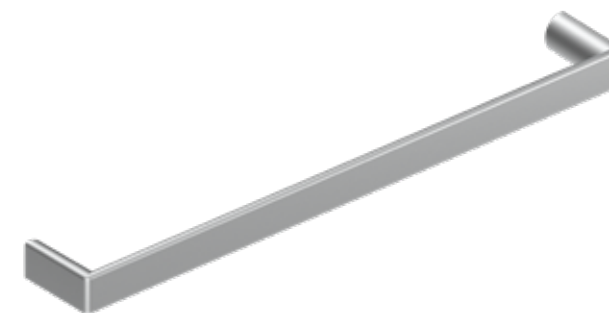

415.26 N

—	102	134	198	326	I	12
○—○	96	128	192	320	┌	27

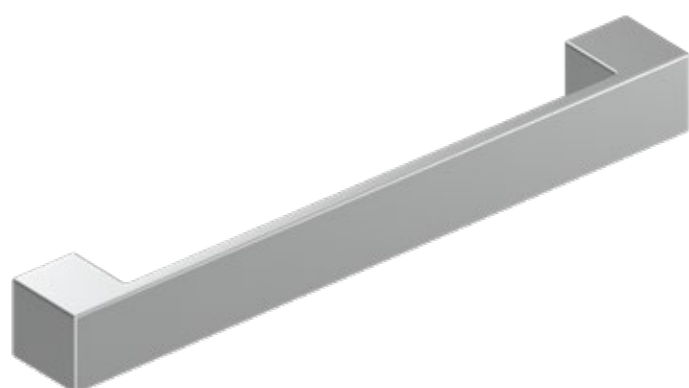

354.25

—	115	156	227	322	I	25	20	25	25
○—○	96	128	192	288	┌	28	24	28	28

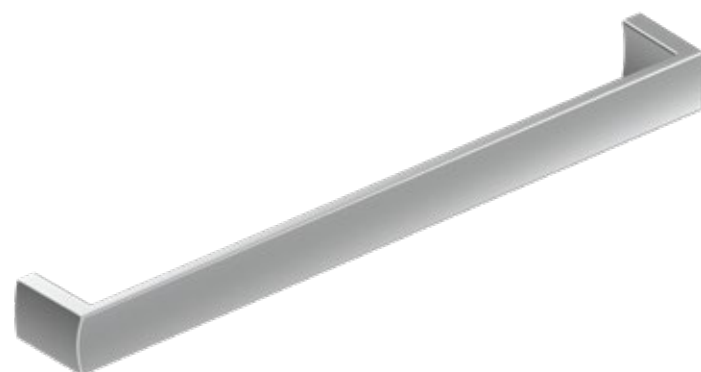

569.28

—	167	231	I	19
○—○	160	224	┌	28



832.28

—	19	I	19
		┌	28



Metal / Kovina

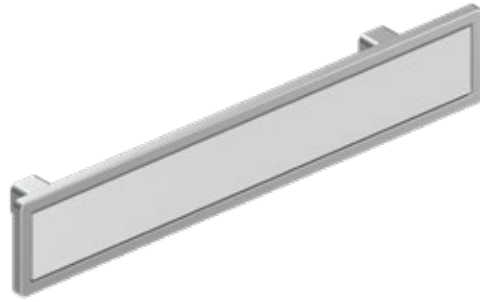

516.30

┌──┐	170	234	I	30
○─○	128	192	┌─┐	24



826.30

┌──┐	30	I	30
		┌─┐	24



516.30 B

┌──┐	170	234	I	30
○─○	128	192	┌─┐	25



826.30 B

┌──┐	30	I	30
		┌─┐	25



516.30 E

┌──┐	170	234	I	30
○─○	128	192	┌─┐	24



826.30 E

┌──┐	30	I	30
		┌─┐	24



361.25

┌──┐	130	165	205	I	20	25	30
○─○	96	128	160	┌─┐	21	24	25



362.21

┌──┐	30	I	30
		┌─┐	24



462.25

┌──┐	130	165	205	I	20	25	30
○─○	96	128	160	┌─┐	21	24	25



362.21 A

┌──┐	30	I	30
		┌─┐	24



396.25

┌──┐	130	165	205	I	20	25	30
○─○	96	128	160	┌─┐	21	24	25



362.21 D

┌──┐	30	I	30
		┌─┐	24



496.14

┌──┐	169	I	14
○—○	160	┌──┐	29



497.22

┌──┐	191	I	22
○—○	160	┌──┐	28



446.24 R

┌──┐	153	187	258	I	15	15	15
○—○	128	160	224	┌──┐	25	28	30



304.16

┌──┐	113	148	I	17	22
○—○	96	128	┌──┐	28	30



360.28

┌──┐	190	I	15
○—○	160	┌──┐	28



367.20

┌──┐	30	I	28
○—○	16	┌──┐	21



447.20 R

┌──┐	135	179	211	I	20	22	24
○—○	96	128	160	┌──┐	24	25	26



604.27

— —	175	239	I	26
○—○	160	224	┌	27



437.20

— —	200	250	I	20
○—○	160	224	┌	19

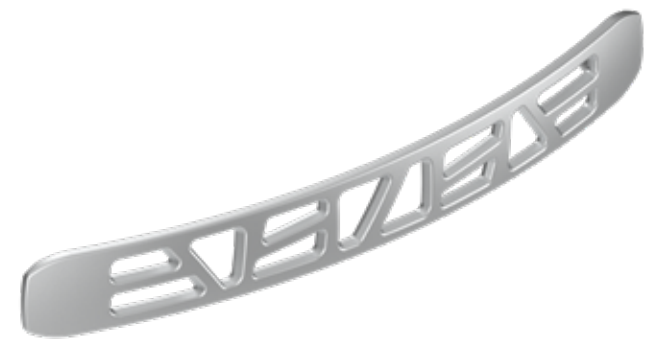

691.26

— —	228		I	26
○—○	192		┌	26



583.19

—	136	168	I	19	19
○—○	96/128	128/160	┌	22	25



386.20

—	180	I	20
○—○	160	┌	25



311.20

—	45	I	20
○—○	25	┌	20

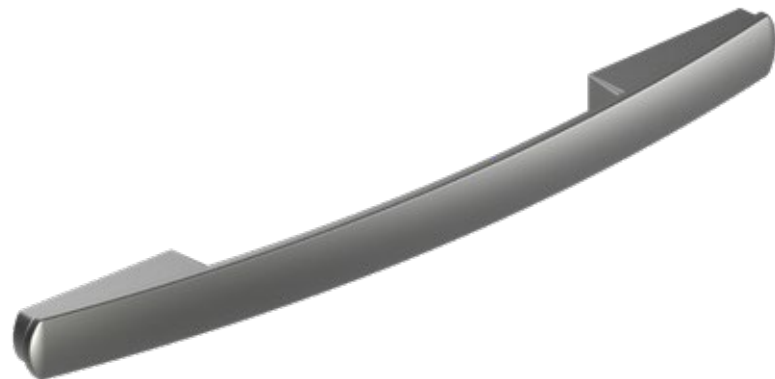

387.20

—	275	I	20
○—○	160	┌	26



692.18

—	177	337	I	18
○—○	160	320	┌	26



557.02

┌──┐	50	I	50
○—○	32	┌──┐	20

557.01

┌──┐	30	I	80
○—○	16	┌──┐	24



557.03

┌──┐	80	I	80
○—○	64	┌──┐	24



557.04

┌──┐	175	I	50
○—○	128	┌──┐	20



(590.03)



(590.01)



590.02

Matching knob (590.01, 590.30) info – page 170

┌──┐	122	I	37
○—○	32	┌──┐	23

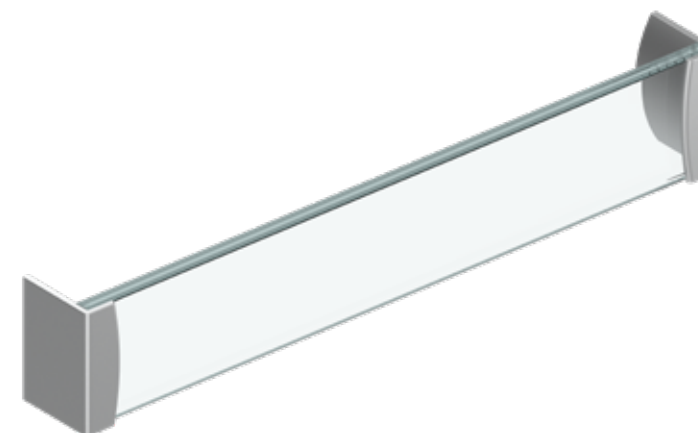

528.03

┌──┐	233	329	I	40
○—○	224	320	┌──┐	28



807.24 ∅ fi 24 ┆ 21



836.26 ┆ 18 I 14
┆ 26



367.20 ┆ 30 I 28
○—○ 16 ┆ 21



851.40 ∅ fi 40 ┆ 26



851.30 ∅ fi 30 ┆ 26



160.12 ∅ fi 12 ┆ 21



667.20 ┆ 28 I 28
┆ 29



199.15 ┆ 15 I 15
┆ 23



199.15 D ┆ 18 I 18
┆ 25



161.19 ∅ fi 19 ┆ 15



162.24 ∅ fi 24 ┆ 20



MS 3.28 ∅ fi 28 ┆ 21



163.26 ∅ fi 26 ┆ 28



809.24 ∅ fi 24 ┆ 28



823.18 ∅ fi 18 ┆ 26



MS 5.20 ∅ fi 20 ┆ 24



MS 5.25 ∅ fi 25 ┆ 29



MS 7.25 ∅ fi 25 ┆ 20



805.13 ∅ fi 13 ┆ 29



833.20 ∅ fi 20 ┆ 28



850.40 ∅ fi 40 ┆ 30



MS 4.28 ∅ fi 28 ┆ 21



MS 6.25 ∅ fi 25 ┆ 24



MS 6.38 ∅ fi 38 ┆ 32



826.30 — 30 I 30
— 24



826.30 B — 30 I 30
— 25



826.30 D — 30 I 30
— 24



362.21 — 30 I 30
— 16 — 21



362.21 A — 30 I 30
— 16 — 21



362.21 B — 30 I 30
— 16 — 21



826.30 E — 30 I 30
— 24



590.01 — 28 I 29
— 23



590.02 — 49 I 39
— 16 — 23



362.21 C — 30 I 30
— 16 — 21



362.21 D — 30 I 30
— 16 — 21



819.32 — 32 I 17
— 27



720.08 — 80 I 8
— 32 — 24



722.09 — 41 I 9
— 32 — 27



719.26 — 63 I 29
— 16 — 25



718.07 — 40 I 40
— 28



584.19 — 120 I 23
— 96 — 19



454.20 — 74 I 10
— 64 — 20



510.34 — 75 I 34
— 64 — 19



862.37 — 37 I 32
— 19



Vintage style / Staran stil



630.15	—	175	335	527	I	15
	○—○	160	320	512	┌	38

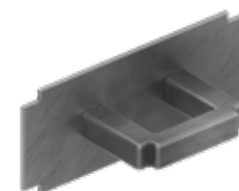

722.09 B	—	86	246	I	36
	○—○	32	192	┌	28



657.16	—	35	210	I	16
	○—○	1	160	┌	39



448.51 R

— 95 I 52
 ○—○ 76 H 15



449.95

— 37 I 95
 ○—○ 56 H 12



636.15

— 182 I 15
 ○—○ 160 H 22



589.02

— 140 I 30
 ○—○ 128 H 25

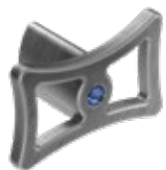

589.01

— 43 I 26
 ○—○ 1 H 23



667.20

— 28 198 I 28 20
 ○—○ 1 128 H 29 29



516.30 C

— 170 I 30
 ○—○ 128 H 24



826.30 C

— 30 I 30
 ○—○ 1 H 24



347.20

— 137 170 233 329 364 I 20
 ○—○ 128 160 224 320 355 H 30

For all other models of handles in vintage finish, please visit / Za vse ostale modele ročajev v starani obdelavi obiščite — rujzdesign.com



220.10 + P4

┆┆	105	I	15
○—○	64	┆┆	25



170.18

∅	fi 26	I	33
		┆┆	13



650.12

┆┆	35	210	I	12
○—○	1	160	┆┆	33



236.16

—	160	I	16
○—○	128	↳	24



128.18

—	28	I	18
		↳	18



114.30

—	30	I	30
		↳	26



114.30 + P3

—	70	I	30
		↳	28



416.14

—	96	I	50
○—○	64	↳	14



815.14

—	33	I	50
		↳	14



851.30

—	30	I	30
		↳	26



MS 7.25

—	25	I	25
		↳	20



681.15

—	144	I	15
○—○	128	↳	26



722.09 B

—	86	246	I	36
○—○	32	192	↳	28

For all other models of handles in classic finish, please visit / Za vse ostale modele ročajev v starani obdelavi obiščite — rujzdesign.com



Wooden handles and knobs



414.14

— 350 I 14
 ○—○ 96 H 34



613.27 B

— 32 160 224 320 416 I 8
 ○—○ 16 128 160 224 320 H 27



541.15

— 170 234 I 15
 ○—○ 160 224 H 30



347.20

— 137 170 233 329 364 I 20
 ○—○ 128 160 224 320 355 H 30

476.15



— —	182	282	332	382	I	15
○—○	170	270	320	370	┌	38

289.26



— —	138	170	234	330	I	26
○—○	128	160	224	320	┌	30



— —	10	I	26
○—○	1	┌	30

556.10



— —	166	198	262	358	454	I	10
○—○	128	160	224	320	416	┌	32

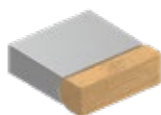

— —	30	I	10
○—○	1	┌	32





259.18

—	148	180	I	34
○—○	128	160	┌	20



285.13

—	103	135	199	I	17
○—○	96	128	192	┌	31



237.13

—	210	242	I	13
○—○	160	192	┌	30



204.16

—	112	I	16
○—○	96	┌	31



213.14

—	126	I	14
○—○	96	┌	23



U1.150 ∅ fi 50 — 55
└ 11+6



U2.135 ∅ fi 35 — 40
└ 11+5



U2.140 ∅ fi 40 — 45
└ 11+5



U2.150 ∅ fi 50 — 55
└ 11+5



810.18 ∅ fi 18 └ 26



132.25 D ∅ fi 25 └ 31



144.32 ∅ fi 32 └ 30



149.35 ∅ fi 35 └ 27



171.32 ∅ fi 32 └ 26



114.30 ∅ fi 30 └ 26



114.30+P3 — 70 I 30
└ 28



118.30 ∅ fi 30 └ 28



L1.05.36 ∅ fi 35 └ 34



L1.03.32 ∅ fi 32 └ 29



L1.04.35 ∅ fi 35 └ 37

Usnjeni ročajji in gumbi

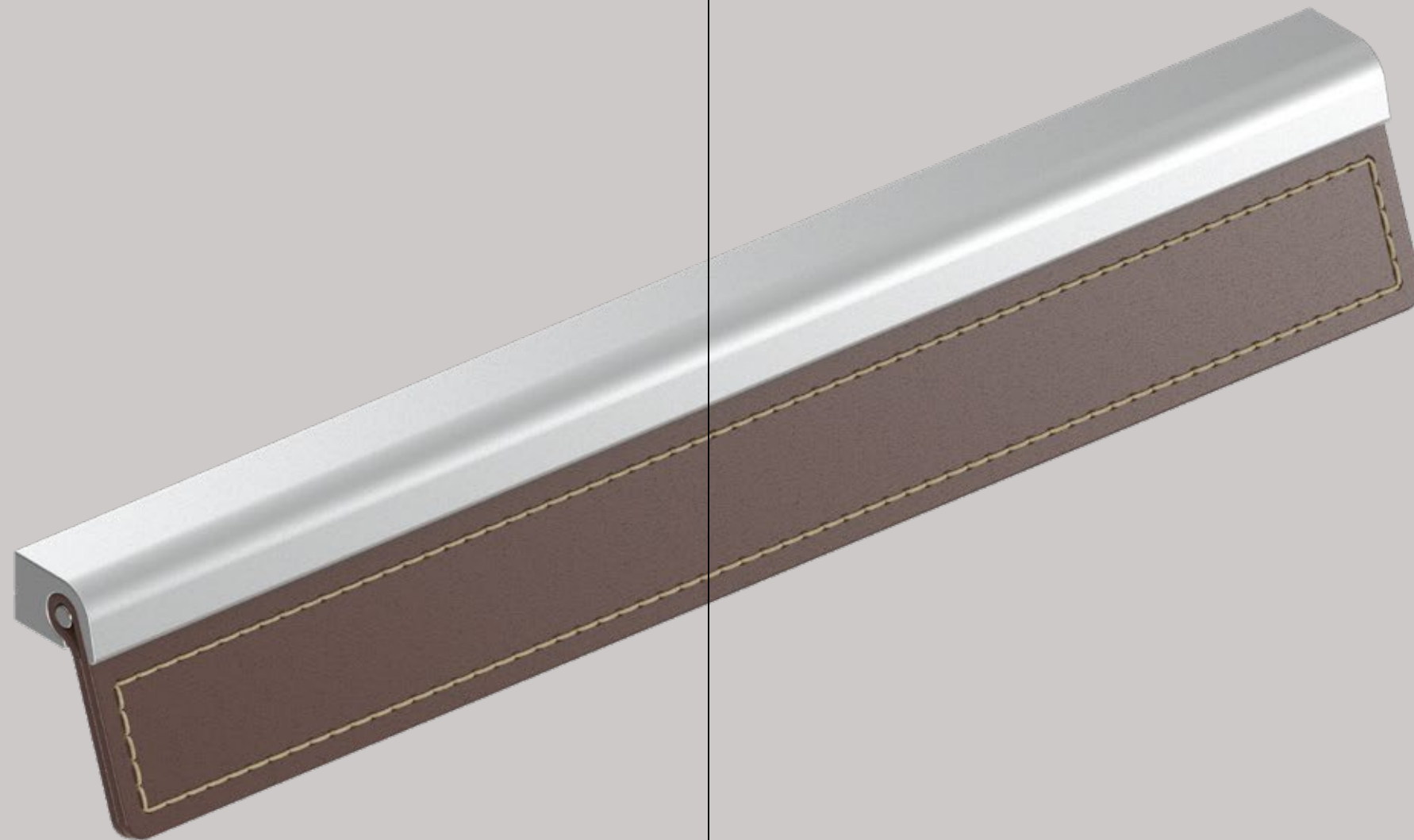

Leather handles and knobs

591.15



┌──┐	30	200	I	32
○─○	16	160	┌─┐	22

592.15



┌──┐	140	169	I	30
○─○	128	160	┌─┐	27

516.30 F



┌──┐	185	250	I	45
○─○	128	192	┌─┐	28

826.30 F



┌──┐	47		I	47
			┌─┐	27

322.16



┌──┐	230	390	I	16
○─○	160	320	┌─┐	37

577.19



┌──┐	215	630	I	19
○─○	160	544	┌─┐	40

855.25



┌──┐	25		I	69
			┌─┐	20

157.16



⊙	fi 20		I	23
			┌─┐	44

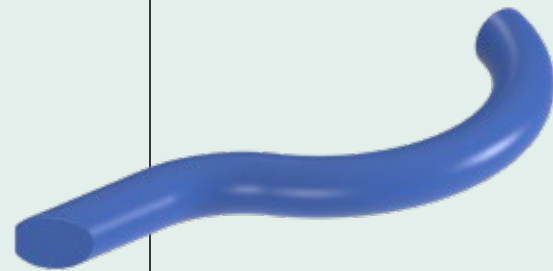



154.40 — 35 I 33
┆ 25



155.40 ⊗ fi 40 I 29



843.22 — 45 I 41
┆ 23



106.14 ⊗ fi 15 ┆ 25



109.20 ⊗ fi 20 ┆ 24



117.30 ⊗ fi 28 ┆ 30



846.25 — 53 I 56
┆ 25



844.24 — 27 I 56
┆ 24



845.27 — 70 I 52
┆ 27



506.32 — 62 I 62
○—○ 32 ┆ 30



132.25 D ⊗ fi 25 ┆ 31



104.14 ⊗ fi 15 ┆ 18



472.52 — 55 I 50
○—○ 32 ┆ 23



816.70 — 68 I 66
┆ 24



847.24 — 50 I 57
┆ 24

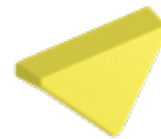

277.32 — 50 I 26
○—○ 32 ┆ 16

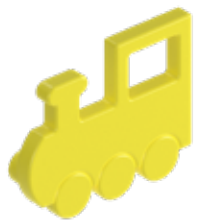

469.50 — 60 I 49
○—○ 32 ┆ 23



470.50 — 55 I 49
○—○ 32 ┆ 23



471.55 — 41 I 55
○—○ 32 ┆ 23



169.30 ⊗ fi 30 ┆ 32



285.13



— —	135	I	17
○—○	128	┌	31

530.24



— —	171	I	12
○—○	160	┌	26

241.08



— —	96	I	9
○—○	64	┌	28

299.08



— —	116	I	15
○—○	96	┌	25





600.00 — 50 I 87
 o—o 64 H 24



600.01 — 50 I 87
 o—o 64 H 24



600.02 — 50 I 87
 o—o 64 H 24



600.03 — 50 I 87
 o—o 64 H 24



600.04 — 50 I 87
 o—o 64 H 24



600.05 — 50 I 87
 o—o 64 H 24



600.06 — 50 I 87
 o—o 64 H 24



600.07 — 50 I 87
 o—o 64 H 24



600.08 — 50 I 87
 o—o 64 H 24



600.09 — 50 I 87
 o—o 64 H 24

599.30



— 205 I 58
○—○ 160 H 30

2154



— 70 I 66
H 3

2153



— 74 I 72
H 3

598.32

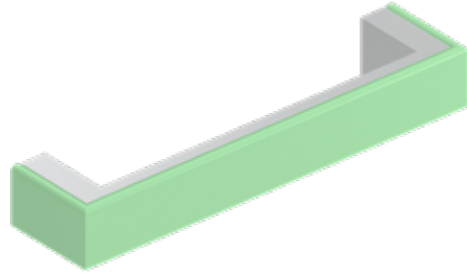

— 144 I 20
○—○ 128 H 33

601.26



— 96 I 85
○—○ 32 H 30

2155



— 66 I 72
H 3

596.22

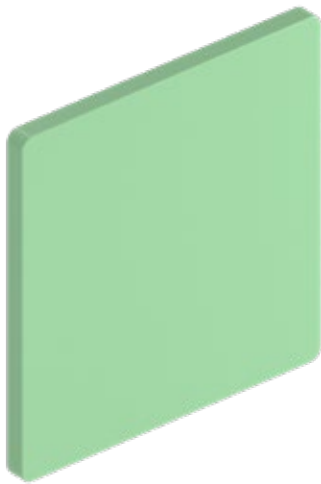

— 110 I 110
○—○ 64 H 22

597.22



— 130 I 34
○—○ 64 H 22

2156



— 73 I 51
H 3

2157



— 136 I 74
H 3

222.13



—	188	220	348	I	12
○—○	128	160	288	H	32

118.30



∅ fi 30 H 28

U2.150



∅ fi 50	—	55
	H	12+5

302.20



—	110	143	173	240	I	17	20	20	20
○—○	96	128	160	224	H	27	27	30	34

114.30



∅ fi 30 H 26

828.40



—	40	I	40
		H	30

331.16



—	198	I	16
○—○	160	H	33

801.16



—	31	I	16
		H	24

171.32



∅ fi 32 H 26

829.100



—	100	I	100
○—○	24	H	36



Round Collection / Kolekcija "Round"



40.019 A — 34 I 34
 — 35



40.019 F — 34 I 93
 — 37



40.019 B — 70 I 70
 — 35

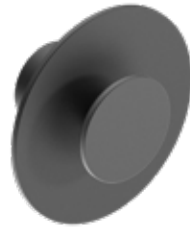

40.019 C — 70 I 70
 — 37



40.019 E — 70 I 111
 — 37



40.019 G — 70 I 70
 — 37



40.019 D — 70 I 111
 — 39



* Possibility of combining colours
/ * Možnost kombiniranja barv





40.018 B — 80 I 70
 └ 40

40.018 A — 37 I 32
 └ 19



40.020 — 40 I 40
 └ 28



40.017 — 15 I 68
 └ 32





40.008
 ─── 40 I 40
 ─── 45



40.009
 ─── 30 I 30
 ─── 34



652.20
 ─── 20 I 55
 ○—○ 16 ─── 17



2100
 ─── 32 I 47
 ○—○ 16 ─── 18



2127
 ─── 20 I 20
 ─── 28



2037
 ─── 13 I 29
 ─── 26



2131
 ─── 11 I 11
 ─── 26



2053
 ─── 60 I 55
 ─── 29



2120
 ─── 41 I 60
 ─── 43



2033
 ─── 80 I 80
 ─── 33



40.004 — 61 I 100
 — 47

40.005 — 50 I 117
 — 40



2202 A — 39 I 140
 — 41

2187 A — 30 I 100
 — 33



2088 — 49 I 130
 — 35

2121 — 30 I 130
 — 35



2187 C — 39 I 100
 — 33

2202 C — 39 I 140
 — 41



40.003 — 80 I 76
 — 46

40.003 B — 73 I 28
 — 32



40.013 A — 17 I 140
 — 41

40.013 B — 15 I 100
 — 33



2123 — 75 I 119
 — 47

2124 — 70 I 115
 — 47



2130 — 50 I 100
 — 50

2084 — 9 I 103
 — 60

40.010



— 31 I 94
— 39

2028



— 87 I 116
— 51

2014



— 60 I 121
— 40

222

Rujzdesign



2046

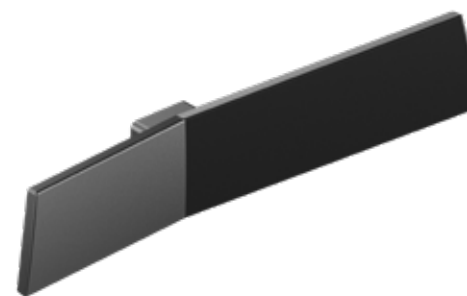

— 163 I 47
— 41

2045



— 89 I 39
— 31

Hangers / Obešalniki

223



40.006

— 200 I 60
 — 10



40.021

— 500 I 118
 — 20



2018

— 45 I 186
 ┆ 60

2030

— 25 I 148
 ┆ 60

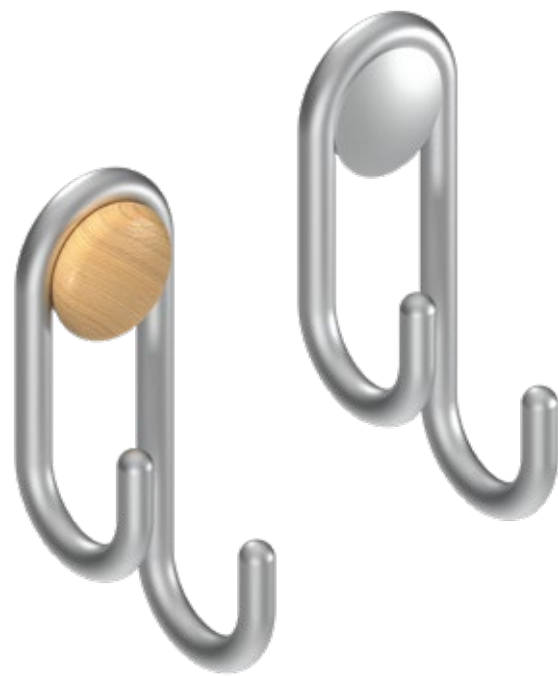

2001

— 55 I 150
 ┆ 53



2013

— 67 I 100
 ┆ 51

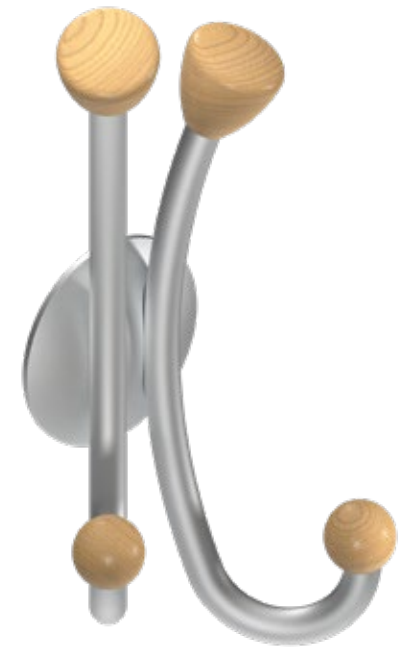

2004

— 107 I 215
 ┆ 66



2087

— 90 I 90
 °—° 45 I 18

169.30

— 30 I 32
 I 30



2010

— 300 I 300
 I 44

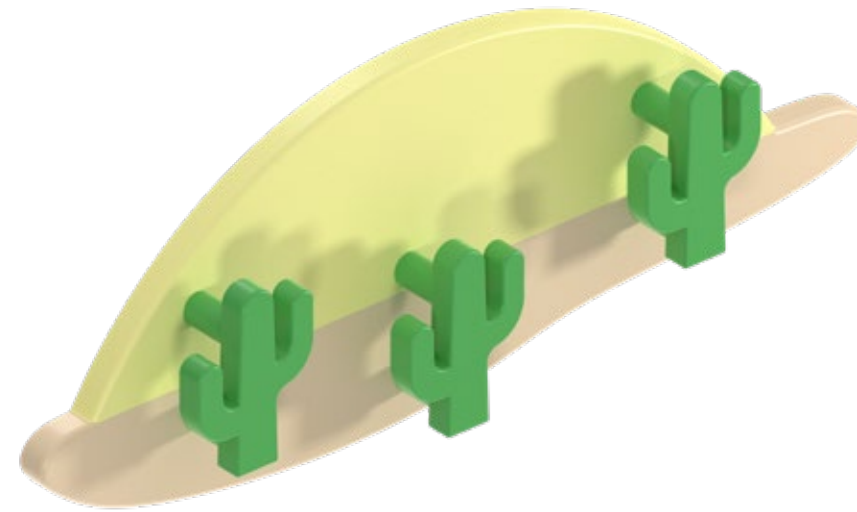

2081

— 294 I 110
 I 36

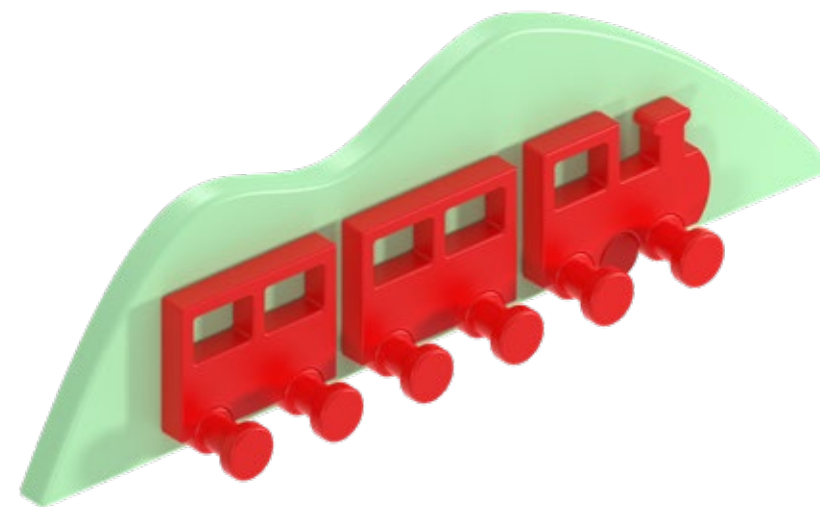

2082

— 280 I 86
 I 35



2092

— 40 I 40
 — 30



2090

— 100 I 100
 ○—○ 24 — 36



Mirror or glass panel featuring various graphic prints
 / Ogljedalo ali stekleni panel s potiskom različnih grafik

TA 2090-92 SET

— 250 I 1500
 — 50

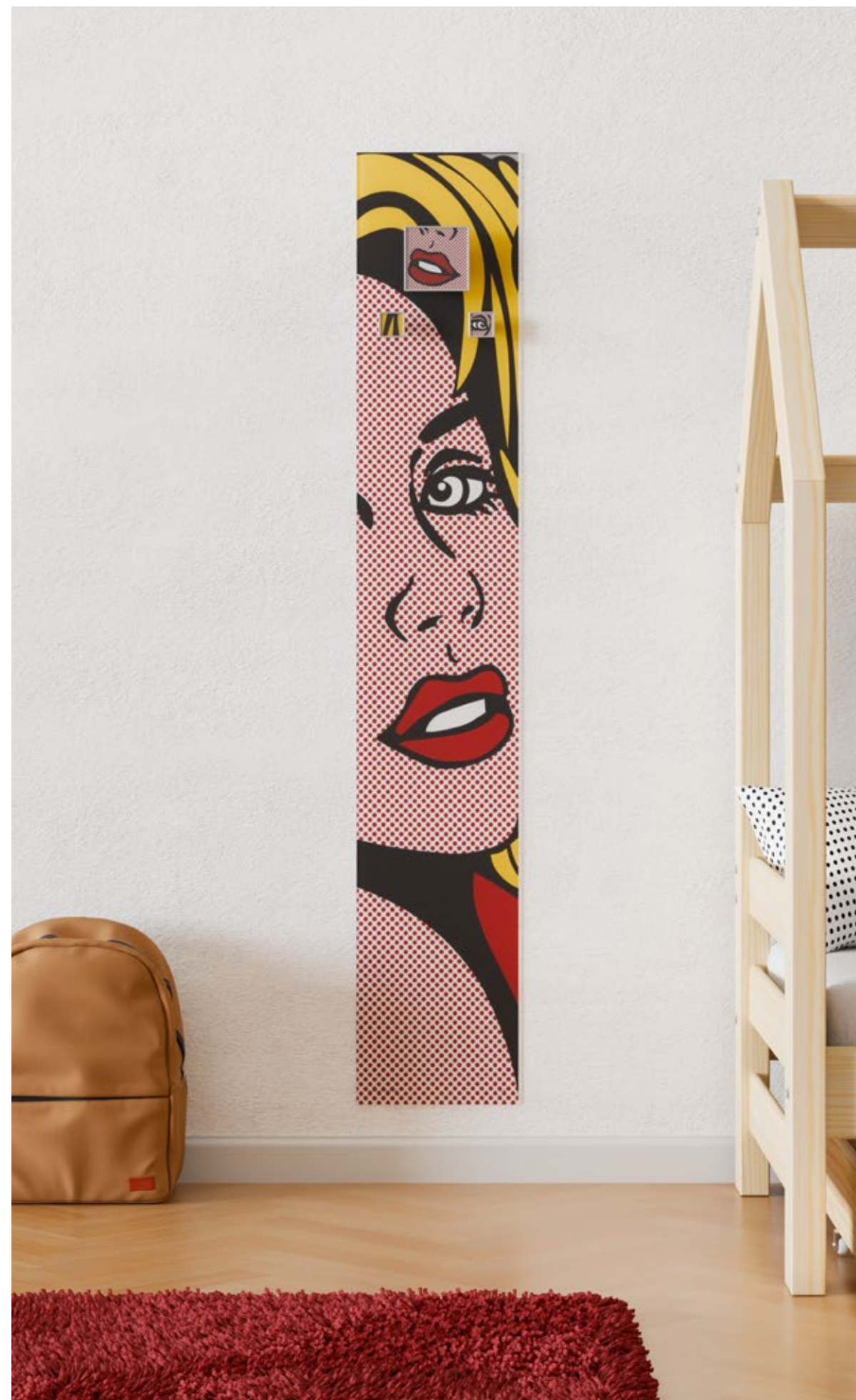

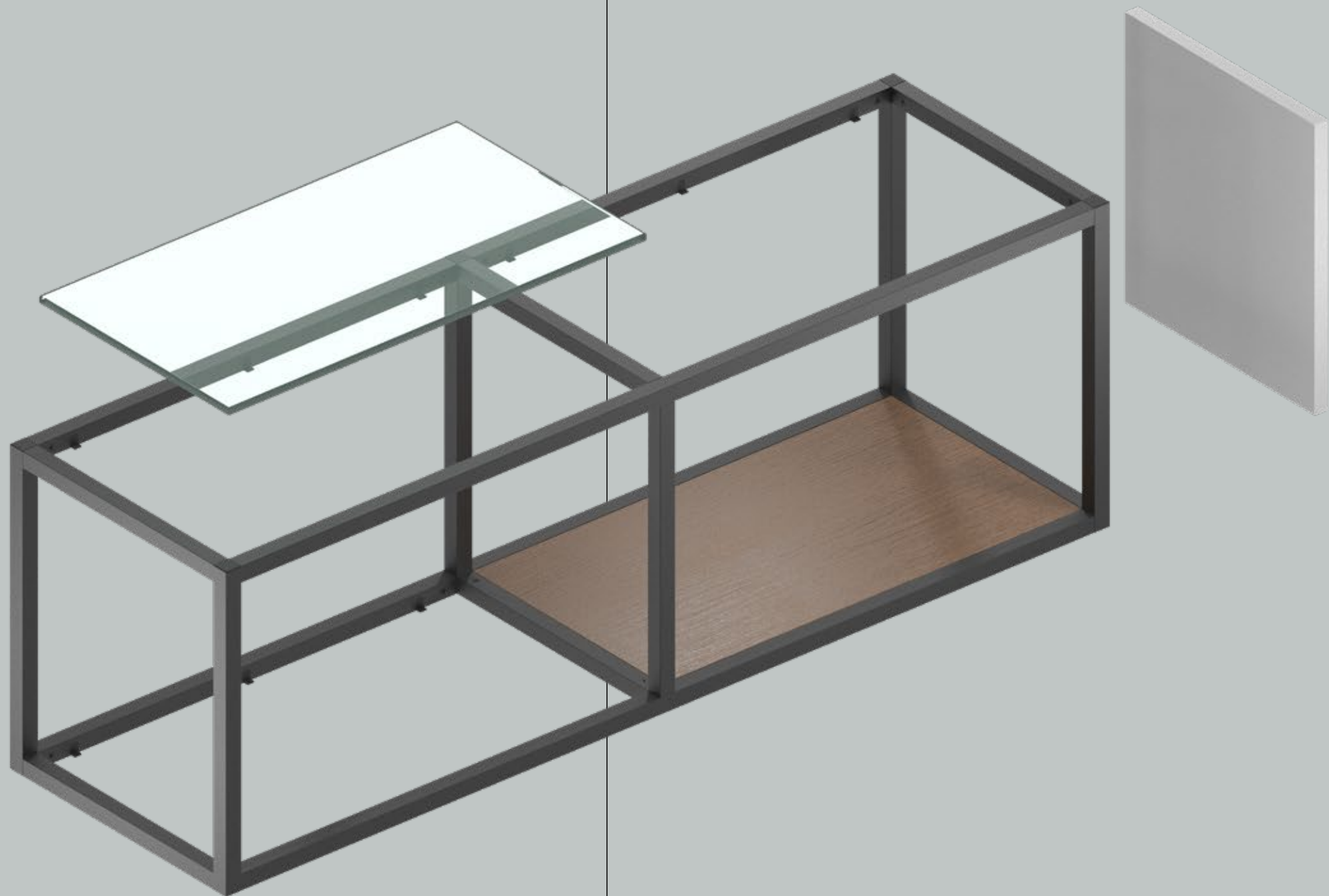

Cubus shelf system



Cubus shelf system

Cubus profile systems

Customisable Shelving for Any Space.

Discover a dynamic shelving system that brings tailor-made organisation to both homes and professional settings.

This modular solution offers unparalleled customisation without sacrificing stability.

Crafted from durable materials, each shelf ensures long-lasting reliability so you can transform any space into a clutter-free, organised haven.

Cubus profilni sistemi

Prilagodljive police za vsak prostor.

Odkrijte dinamičen sistem polic, po meri izdelan za dom, pisarno in druge prostore.

Ta modularna rešitev zagotavlja popolno prilagodljivost in konstrukcijsko stabilnost.

Sistem je izdelan iz trpežnih materialov, kar zagotavlja dolgotrajno zanesljivost. Spoznajte se z našim vsestranskim sistemom in preobrazite svoj prostor v urejeno oazo.

Vertical profile / Vertikalni profil

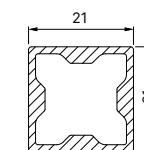

Horizontal profile / Horizontalni profil

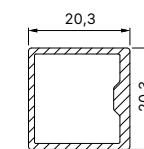

Sliding door profile / Profil za drsna vrata

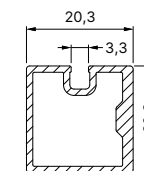

Profile / Profil

Shelf mount / Montaža police

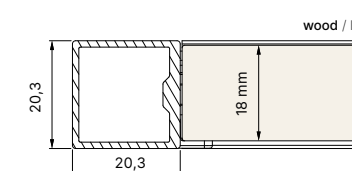
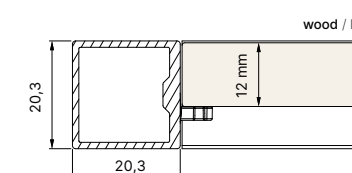
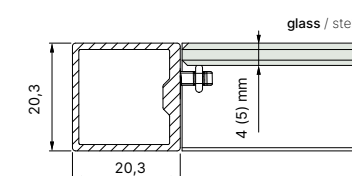



Opt for ready-made or personalise your shelf system according to your preferences – adjust height, width, open or closed design, material (wood/glass), and colour for a customised and stylish storage solution.

Flexible shelving solutions

Odločite se lahko za predpripravljen sistem ali pa ga povsem prilagodite svojim željam in potrebam – prilagajate lahko višino, širino, globino, se odločite za odprto ali zaprto zasnovo, izbirate različne materiale in barve polic (les/steklo) in tako sami zasnujete elegantno rešitev za shranjevanje.

Prilagodljive rešitve za shranjevanje

Cubus shelf system



Well-suited for a variety of environments.

Whether you're looking to enhance your living space, optimise office organisation, elevate hotel sophistication, furnish stylish salons, or create efficient retail displays, our shelf systems provide the perfect solution for diverse needs.

Primerne za različna okolja.

Ne glede na to, ali želite izboljšati svoj bivalni prostor, optimizirati pisarniško organizacijo, nadgraditi hotelske ambiente, opremiti salon ali ustvariti učinkovit prodajni poličnik, naš sistem polic nudi popolno rešitev za različne potrebe.

Cubus shelf system



Choose between different materials / Izbirajte med različnimi materiali

Choose between different handles / Izbirajte med različnimi ročajji



Cubus shelf system

Planning a shelf system has never been easier.

Experience the convenience of creating a custom shelving system that perfectly fits your space and meets your storage needs with our advanced configurator tool.

Načrtovanje sistema polic še nikoli ni bilo lažje.

Spoznajte priročnost ustvarjanja prilagojenega sistema polic kar na domačem zaslonu z našim naprednim orodjem za konfiguracijo. Ustvarite polični sistem, ki se popolnoma prilega vašemu prostoru in ustreza vašim potrebam po shranjevanju.

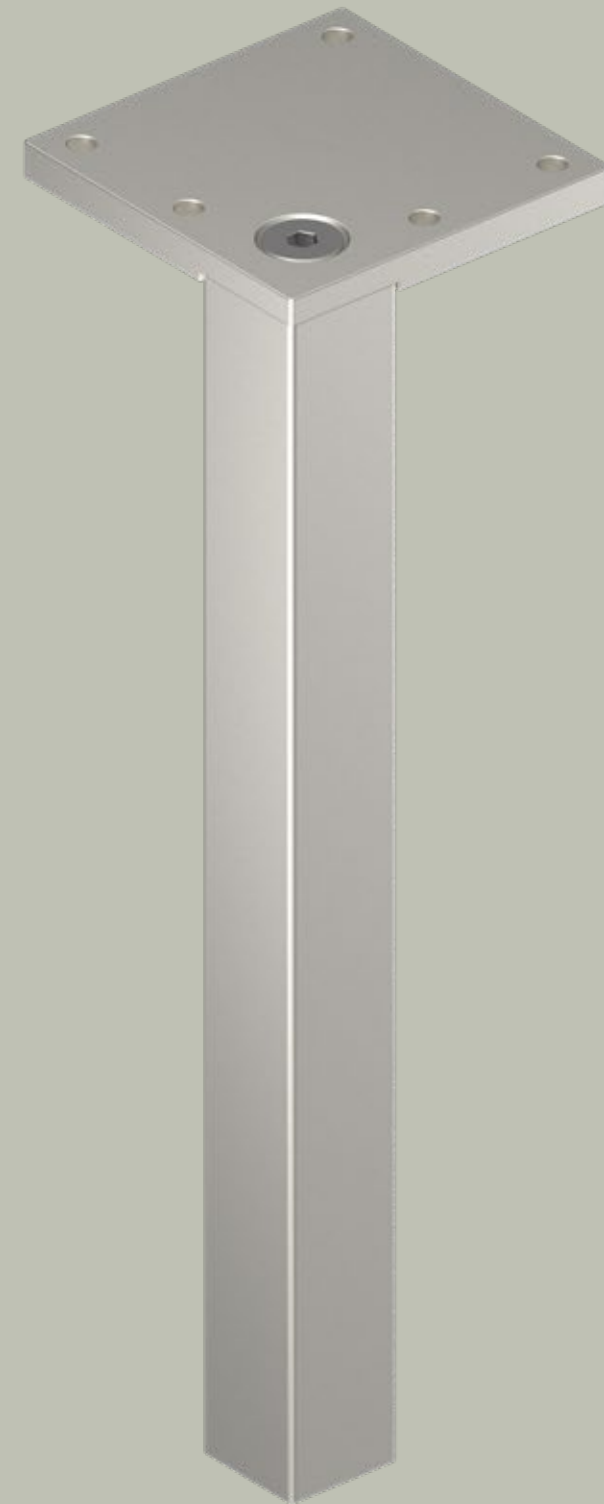

Legs and leg frame systems



2178 R — 50 I 100 150 200
— 6



2184 B — 20 I 100 150 200
— 20



2150 — 37 I 100 150 180
— 37



2158 — 40 I 50 75 100
— 40



2064 — 33 I 65 75 125
— 33



2067 — 25 I 105
— 25



2062 — 50 I 70 130
— 50



2072 — 100 I 230
— 100



2151 — 70 I 180
— 70



2066 — 35 I 110
— 35



2070 — 40 I 100
— 40

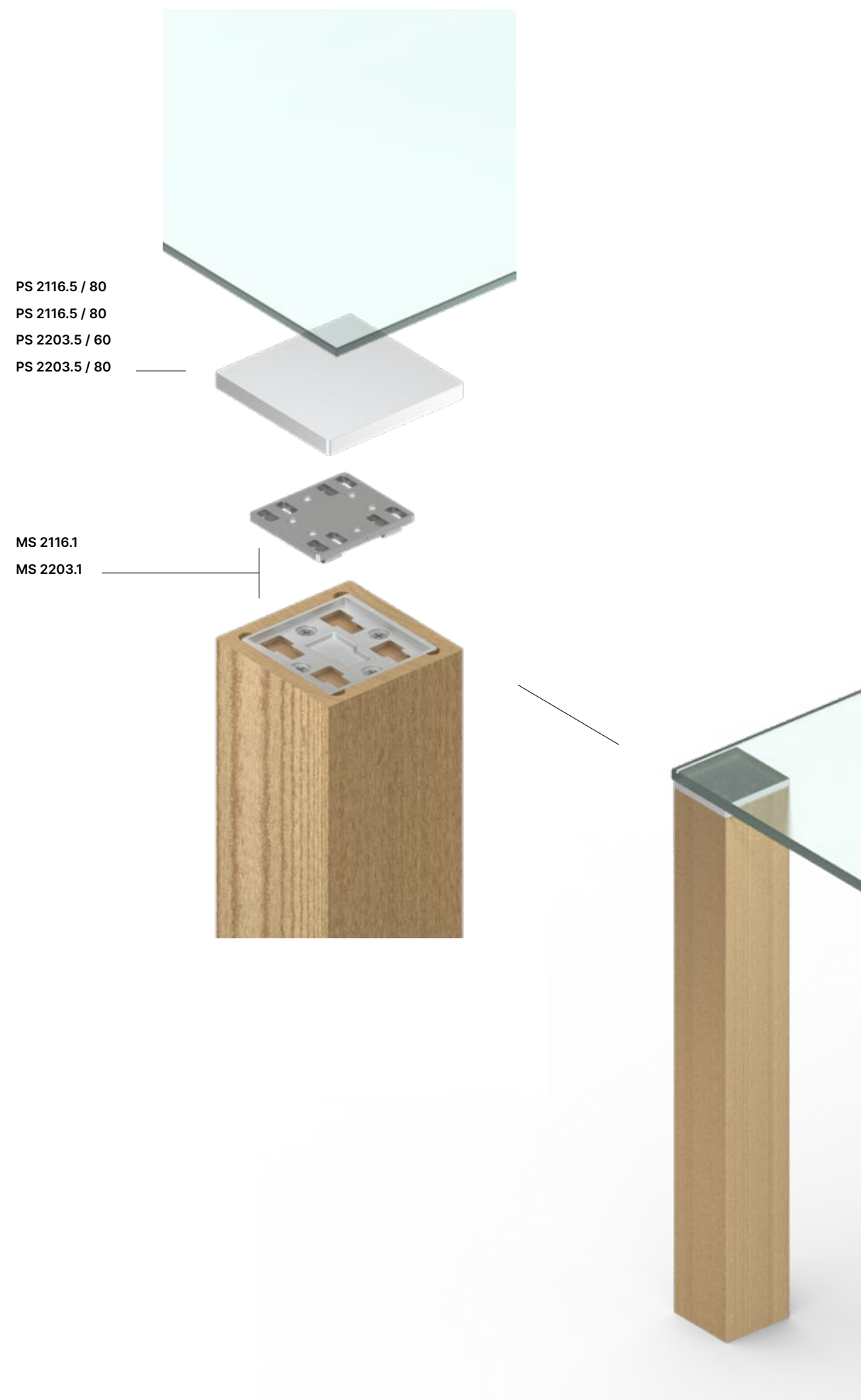
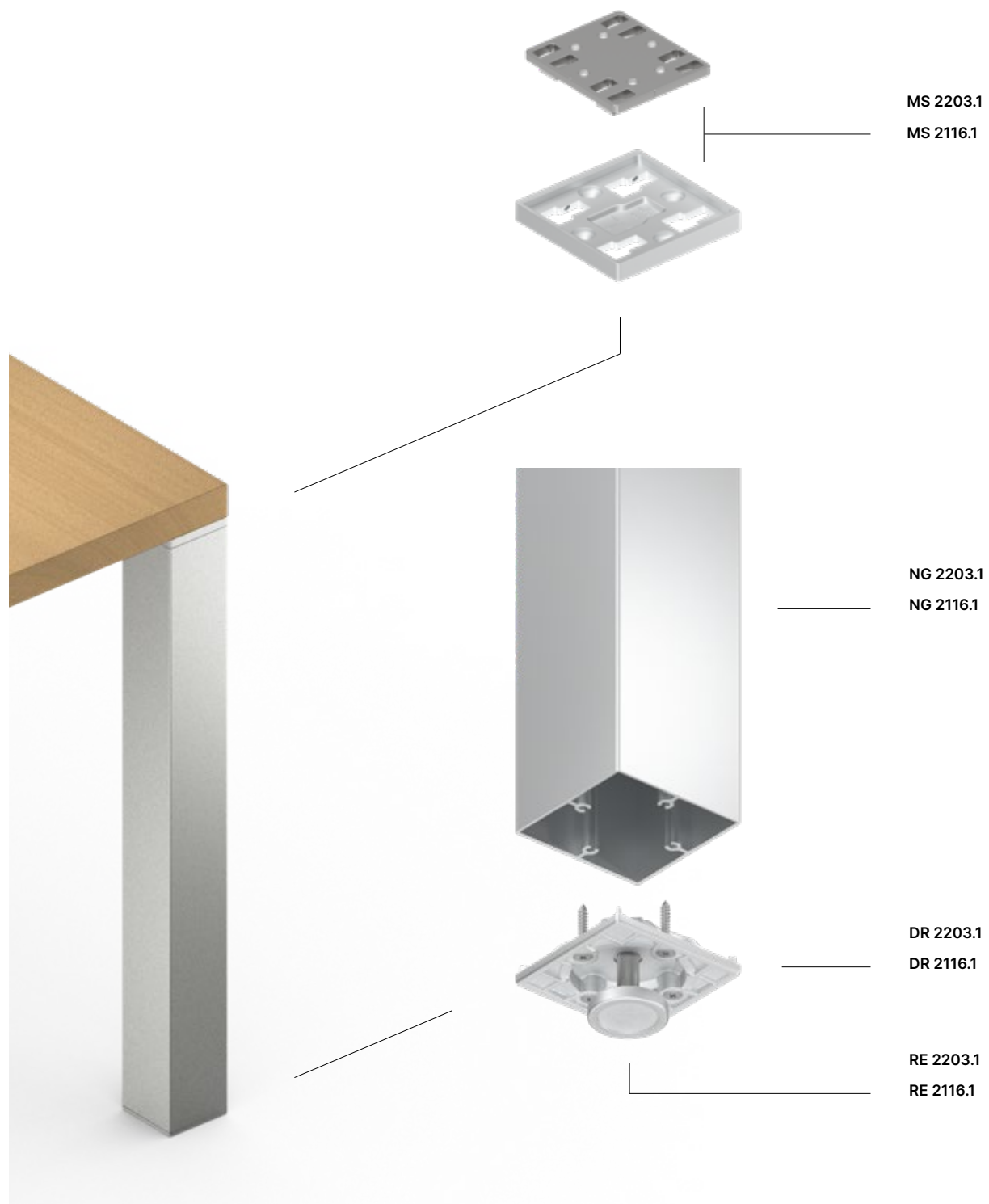

Galvanizacija in izdelki po naročilu

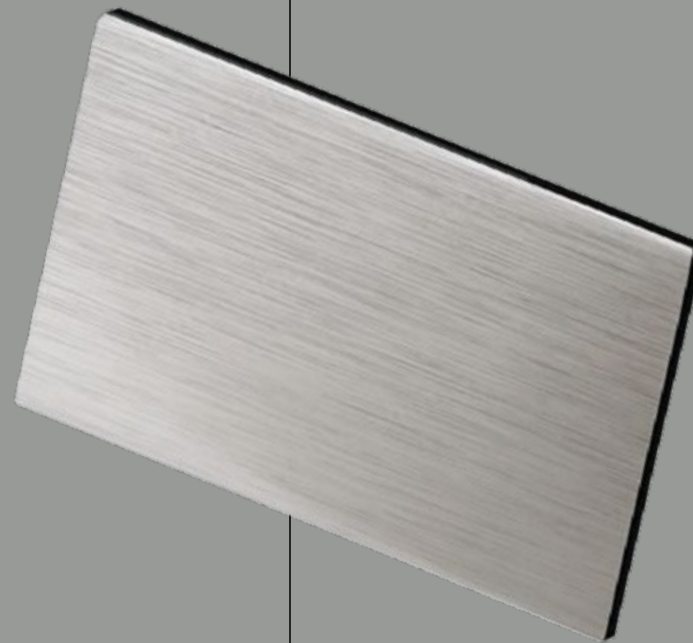

Galvanisation and custom products



Galvanic coatings

Rujzdesign specialises in decorative component coatings, for the visible parts of products that require high attention to detail throughout the galvanising process.

The galvanic surface treatment is a great way to increase the visual appeal of any part and protect it from corrosion and wear and tear.

Rujzdesign also offers an in-house robotic polishing service for your needs.

What do we galvanise?

Our galvanising services are used in a variety of components, such as towel radiators, televisions, motorcycles, oven trays, furniture handles, hooks and decorative elements.

Galvanizacija

Naše podjetje je specializirano za galvanizacijo izdelkov oziroma njihovih sestavnih delov, ki zahtevajo veliko pozornosti in natančnosti.

Kromirana površinska obdelava je odličen način, kako narediti izdelek vizualno privlačnejši. Svetleča prevleka pa je obenem tudi zaščita pred korozijo in obrabo.

Rd Galvanizacija vam poleg galvanizacije ponuja tudi lastno storitev robotskega ter ročnega poliranja.

Kaj galvaniziramo?

Naše storitve galvanizacije se uporabljajo pri raznoraznih komponentah; radiatorji, televizorji, deli motociklov, pladnji za pečice, ročaji za pohištvo, kljuke, dekorativni elementi.

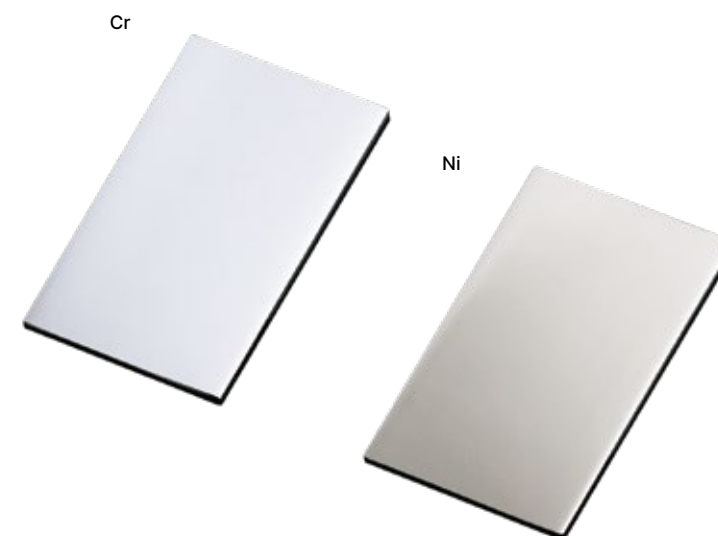

Dimensions and finishes

Maximum dimensions:
1450 x 700 x 400 mm

The maximum surface area of a piece:
180 dm²

Processing materials:
aluminium, steel, inox, brass

Finishes available:
chrome, nickel

Dimenzije in tipi galvanskih obdelav

Maksimalne dimenzije:
1450 x 700 x 400 mm

Maksimalna površina:
180 dm²

Materiali za obdelavo:
aluminij, nerjavna jekla (inox), medenina

Vrste površinskih obdelav:
krom, nikelj

Custom projects

Custom projects can often require multiple decorative parts in the same material and finish to seamlessly tie together the design. We work closely with our partners to turn their designs into prototypes, using our expertise in aluminium and zamak production to create a wide range of decorative elements.

From small scale in a private residence or motorhomes and caravans to a more expansive fit-out with hotels and restaurants, serial kitchen and bathroom productions and multi-unit fit-outs, our tailored service is the perfect fit if you're looking for bespoke special collections or elements to finish off your design.

Izdelki po naročilu

Delo na prilagojenih projektih pogosto zahteva zagotavljanje več dekorativnih elementov iz enakega materiala in z enako obdelavo. Naše znanje v proizvodnji aluminijastih in zamak izdelkov je prednost za naše partnerje. Razvijamo prototipe na podlagi zasnov naših partnerjev in tesno sodelujemo pri ustvarjanju celotne palete elementov zanje, ne zgolj ročajev in obešalnikov.

Izdelamo lahko posebne kolekcije izdelkov ali elemente za opremo hotelov in zasebnih rezidenc, restavracij, avtomodomov in prikolic, kuhinj, kopalnic in drugih prostorov.



An example of a custom project

Primer izvedbe projekta po naročilu

custom frames / okvirji po naročilu

custom panels / okrasne plošče po naročilu

custom handles / ročajji 1 po naročilu

custom handles / ročajji 2 po naročilu

custom shelf holdes / držala polic po naročilu

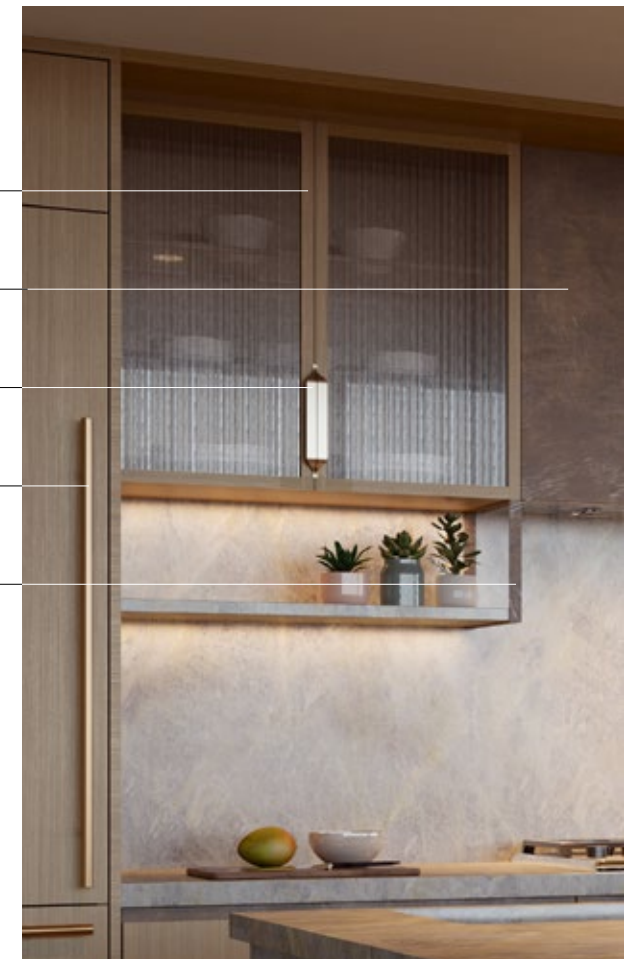

For all available colours and finishes visit /
za vse informacije o razpoložljivih barvah
in obdelavah, obiščite

TOPMATIC

rujzdesign.com

TopMatic e.U.
Mittergradneggerstraße 21/4
9020 Klagenfurt

office@topmatic.at
+43664 4344005

Rd
—