

# PRODUCT CATALOGUE



**PRODUCTS**

2025

**VOCA<sup>x</sup>**

# CONTENT



<b>TABLE BASES</b>	<b>3</b>
SYSTEM HIDE	4
SYSTEM DESK BAR	18
SYSTEM EDGE	31
SYSTEM KOTA	37
SYSTEM SOLO	41
SYSTEM BACK	45
SELF-STANDING LEGS	48
SELF-STANDING TABLE BASES	62
ELTIPLA	88
<b>SHELVING SYSTEM</b>	<b>92</b>
SYSTEM GRIDO	93
<b>HANGERS</b>	<b>94</b>
<b>HANGING WALL</b>	<b>97</b>
<b>FURNITURE BASES</b>	<b>101</b>
<b>ACCESSORIES FOR ALL SYSTEMS</b>	<b>107</b>



# TABLE BASES

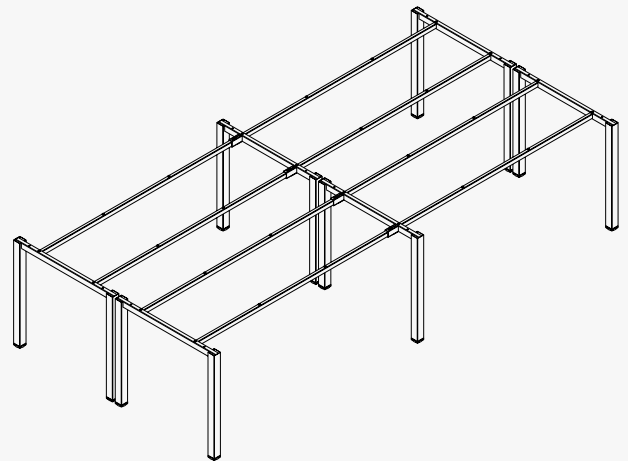
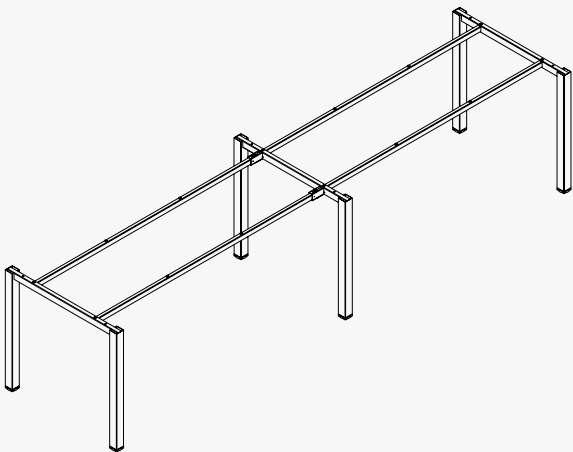
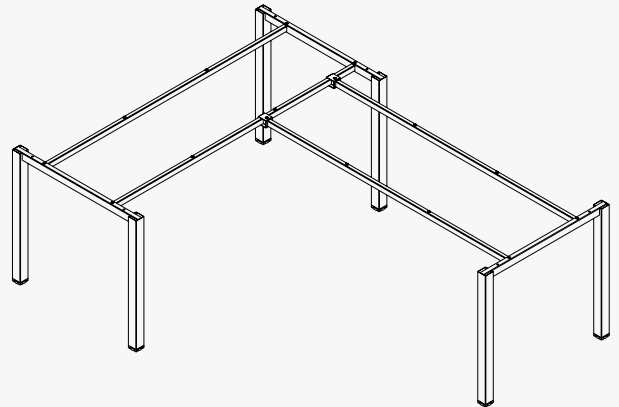
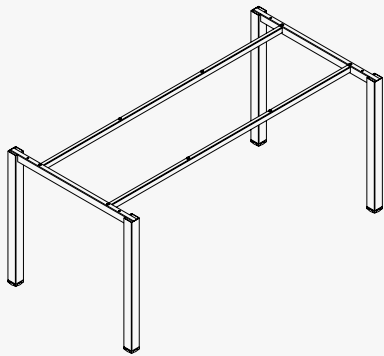

Table bases are unique solutions that offers you many unexpected design combinations.

# SYSTEM HIDE



WATCH VIDEO



# HUBO

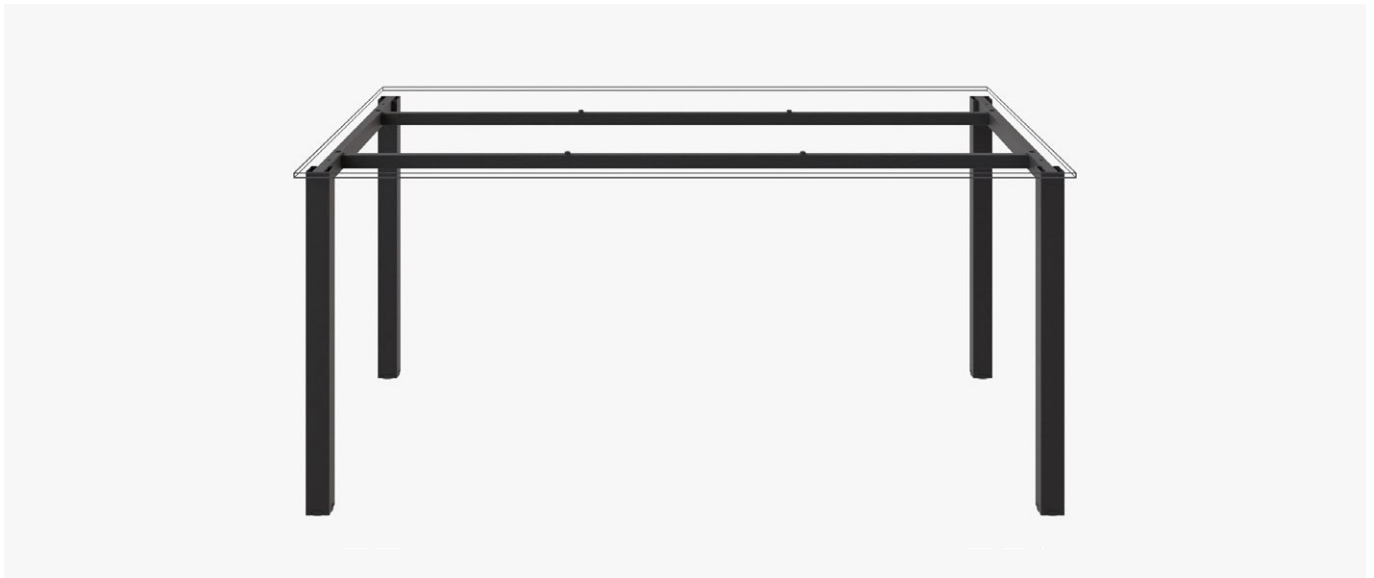

## HUBO 50/600

31419 | RAL 9006G  
21419 | RAL 9005FE

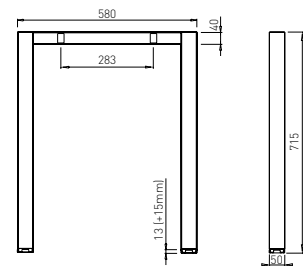

## HUBO 50/800

31420 | RAL 9006G  
21420 | RAL 9005FE

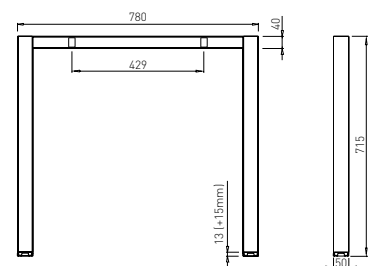

## HEIGHT-ADJUSTABLE PLUG CUBO

30709 | RAL 7015 plastic  
20709 | RAL 9005 plastic

Two plug sets are required for one leg.  
Using the plugs, the height of the table  
can be adjusted from 736 to 856 mm.

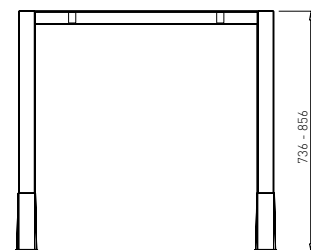
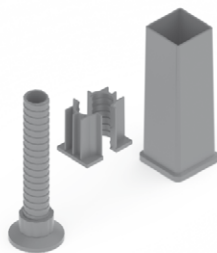

# HOXO

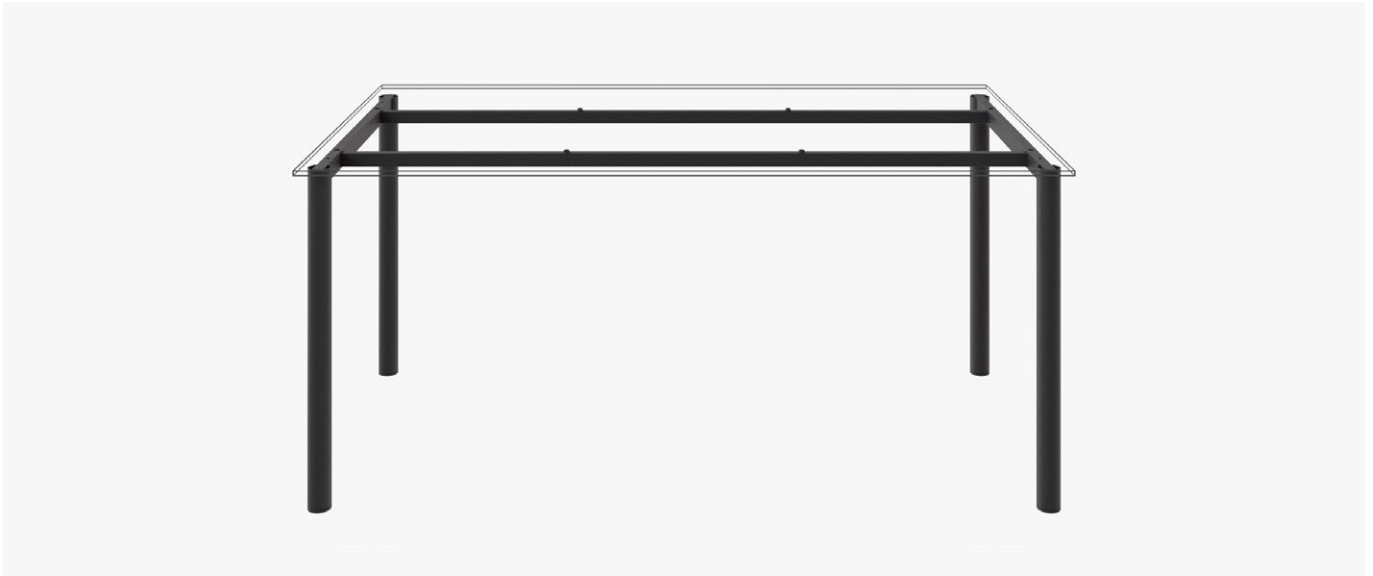

## HOXO 50/600

31430 | RAL 9006G  
21430 | RAL 9005FE

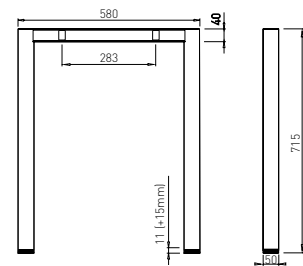

## HOXO 50/800

31431 | RAL 9006G  
21431 | RAL 9005FE

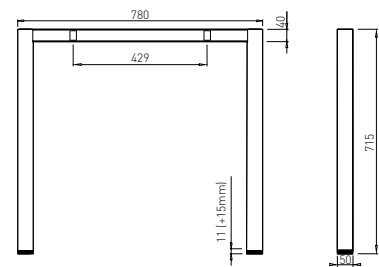

## HEIGHT-ADJUSTABLE PLUG OXO

30704 | RAL 7015 plastic  
20704 | RAL 9005 plastic

Two plug sets are required for one leg.  
Using the plugs, the height of the table  
can be adjusted from 736 to 856 mm.

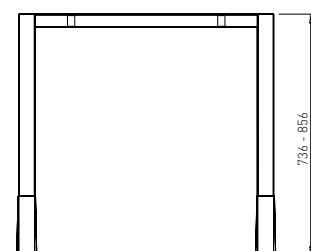
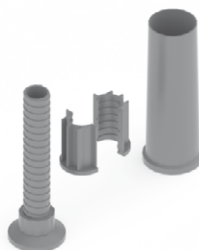

# HIWOOD



## HIWOOD FE ø50/800

31495 | RAL 9005FE, oiled oak

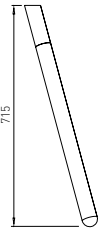
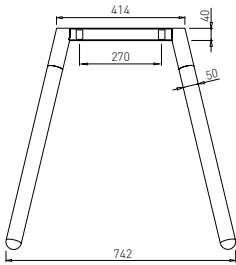

### EXAMPLE

Min. length of table plate 1000 -  
connector 600

Length of connector = length of  
table plate - 400 mm

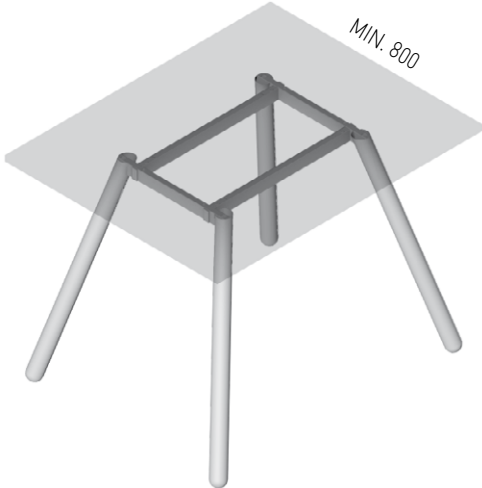

# HIWOOD



## HIWOOD FE 70x30/800

31494 | RAL 9005FE, oiled oak

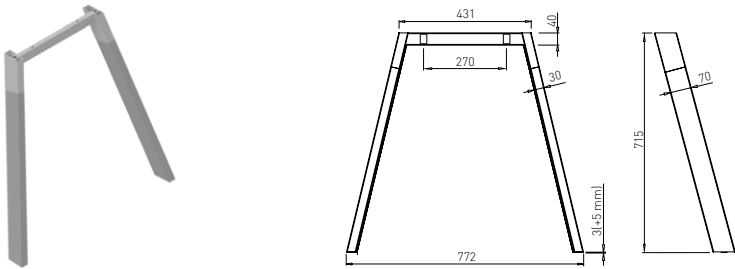

### EXAMPLE

Min. length of table plate 1000 -  
connector 600

Length of connector = length of  
table plate - 400 mm

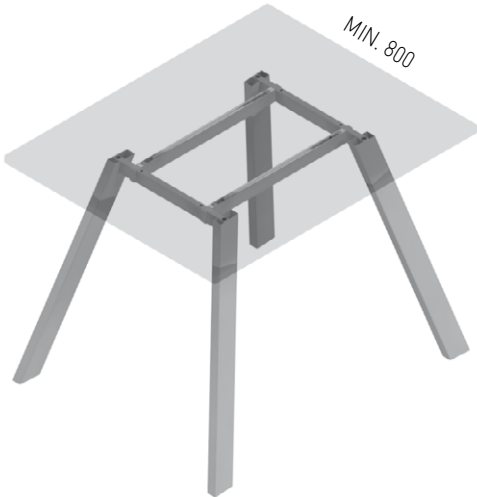

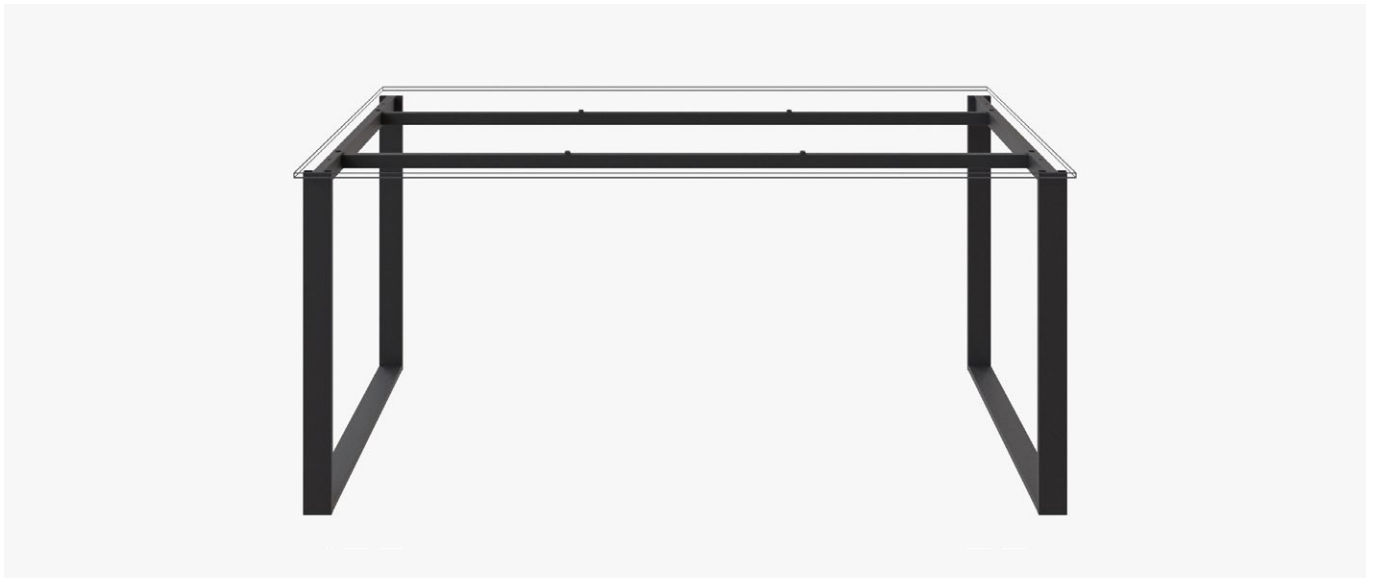

## HQ 600

**31432** | RAL 9006G  
**21432** | RAL 9005FE

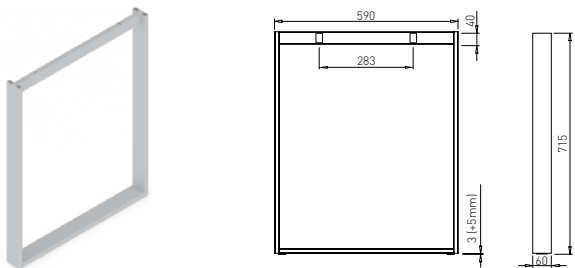

## HQ 600 HV

**31434** | RAL 9006G  
**21434** | RAL 9005FE

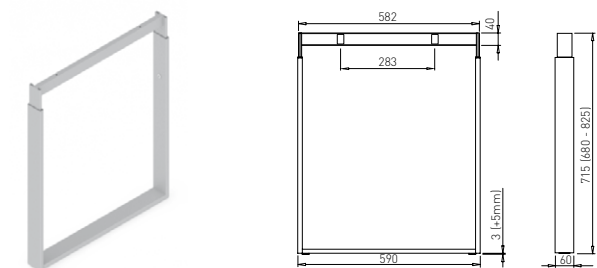

## HQ 800

**31433** | RAL 9006G  
**21433** | RAL 9005FE

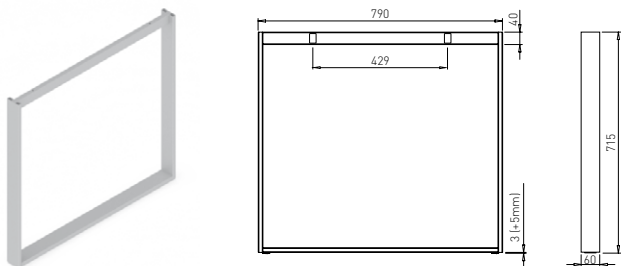

## HQ 800 HV

**31435** | RAL 9006G  
**21435** | RAL 9005FE

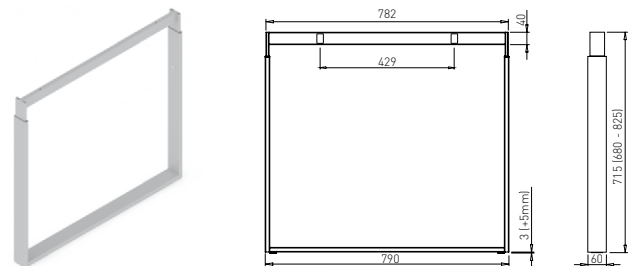

# CON



## CON ø40/800

31521 | RAL 9005FE, oiled oak

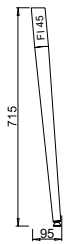
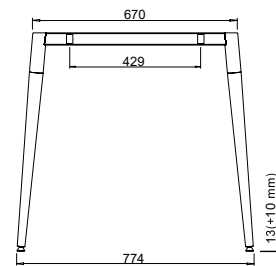

### EXAMPLE

Min. length of table plate 800 -  
connector 700

Length of connector = length of  
table plate - 100 mm



# CON

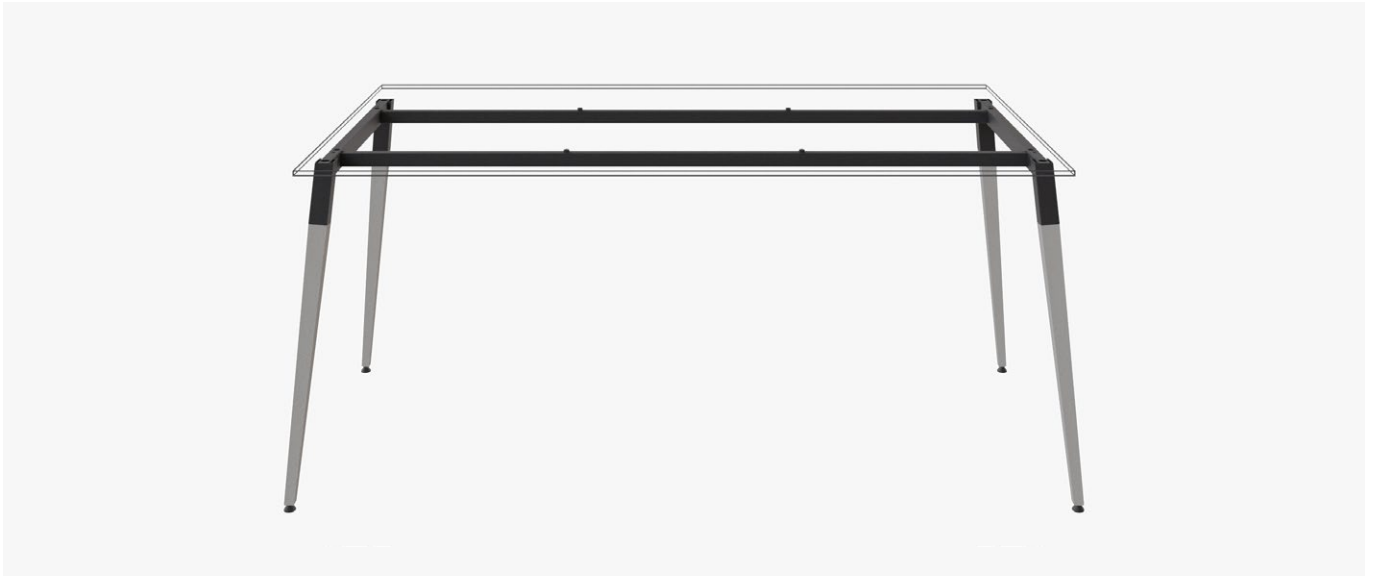

## CON 40x40/800

31522 | RAL 9005FE, oiled oak

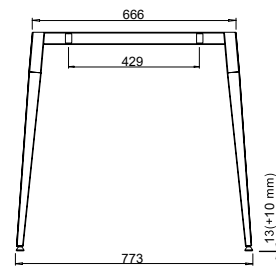

### EXAMPLE

Min. length of table plate 800 -  
connector 700

Length of connector = length of  
table plate - 100 mm



# HA SIDE



## HA-SIDE 60x20/800

31395 | RAL 9006G

21395 | RAL 9005FE

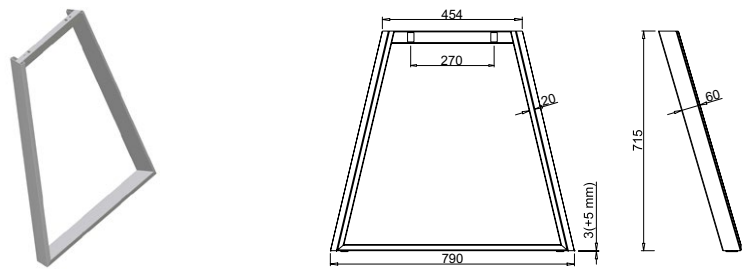

Due to the special shape of the HA-SIDE legs, the length of the connectors = the length of the table top minus 400 mm.



# ASTER



## ASTER 80x80

31304 | RAL 9006G

21304 | RAL 9005FE

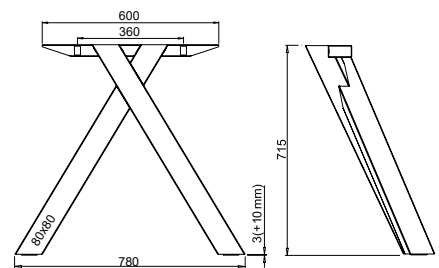

Due to the special shape of the ASTER legs, the length of the connectors = the length of the table top minus 600 mm

SUITABLE FOR TABLE TOPS LENGTH: 1000-2500 MM  
SUITABLE FOR TABLE TOPS WIDTH: 850-1200 MM

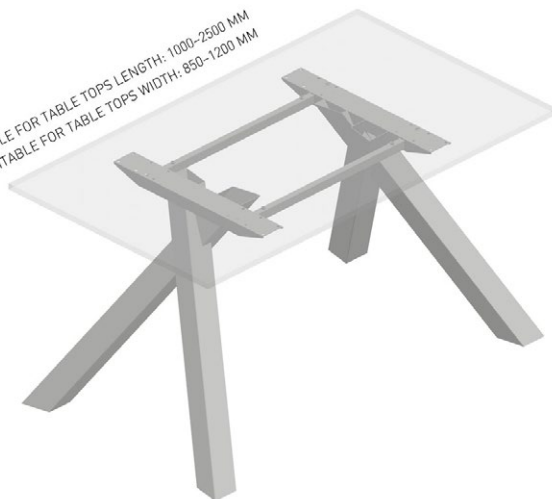

# ASTER



## ASTER $\varnothing 80$

31306 | RAL 9006G

21306 | RAL 9005FE

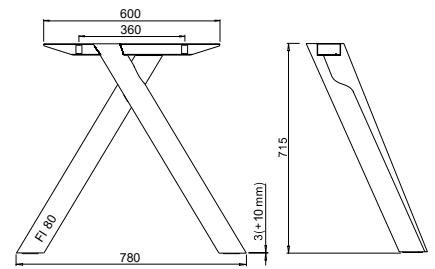

SUITABLE FOR TABLE TOPS LENGTH: 1000-2500 MM  
SUITABLE FOR TABLE TOPS WIDTH: 850-1200 MM

Due to the special shape of the ASTER legs, the length of the connectors = the length of the table top minus 600 mm



# CONNECTORS AND ACCESSORIES

## CONNECTORS HIDE

Product name	Length	RAL 9006G	RAL 9005FE
Connector 600	551 mm	31496	21496
Connector 800	751 mm	31421	21421
Connector 1000	951 mm	31422	21422
Connector 1200	1151 mm	31423	21423
Connector 1400	1351 mm	31424	21424
Connector 1600	1551 mm	31425	21425
Connector 1800	1751 mm	31426	21426
Connector 2000	1951 mm	31427	21427

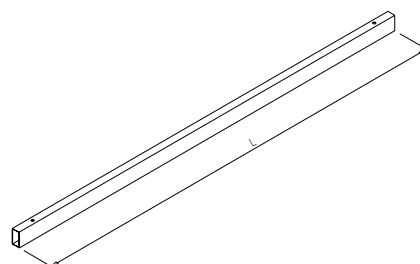

## CONNECTORS HIDE TELESCOPIC

Product name	RAL 9006G	RAL 9005FE
Connector 900–1400	31439	21439
Connector 1500–2000	31438	21438

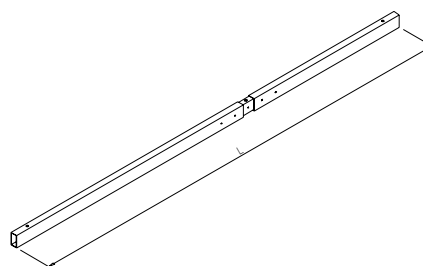
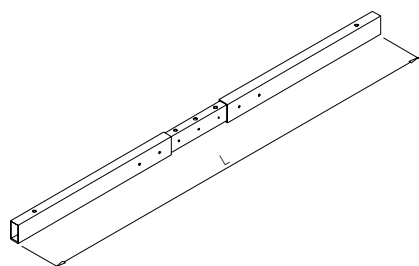

---

## CORNER CONNECTOR HIDE

31436 | RAL 9006G  
21436 | RAL 9005FE

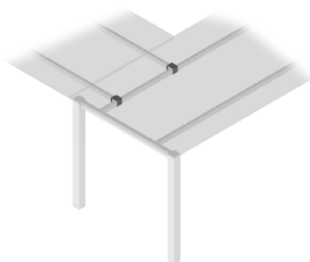

2 X

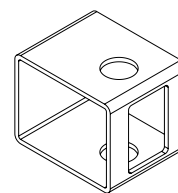

---

## CONNECTING EXTENSION HIDE

31440 | RAL 9006G  
21440 | RAL 9005FE

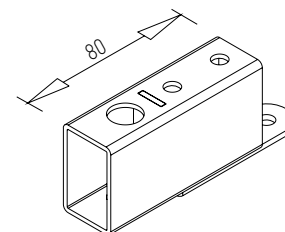

---

## SUPPORTER HIDE

31485 | RAL 9006G  
21485 | RAL 9005FE

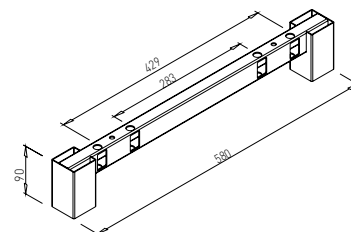
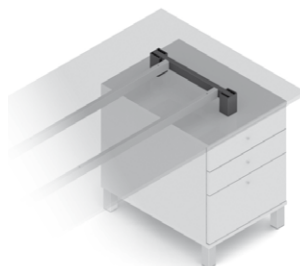

---

## COMPUTER HOLDER

30846 | RAL 9006G  
20846 | RAL 9005FE

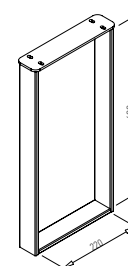
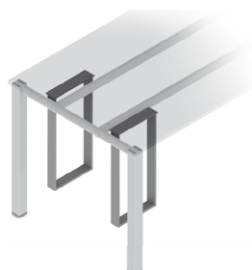

---

## WIRE SHELF

31498 | RAL 9006G  
21498 | RAL 9005FE

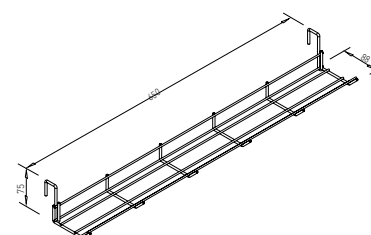

# ANGULAR SOLUTION

For legs HUBO, HOXO and HQ

**connector - 200 mm = table plate dimension**

connector	table plate dimen.
800 mm 6	00 mm
1000 mm	800 mm
1200 mm	1000 mm
1400 mm	1200 mm
1600 mm	1400 mm
1800 mm	1600 mm
2000 mm	1800 mm

**connector = table plate dimension**

connector	table plate dimen.
1400 mm	1400 mm
1600 mm	1600 mm
1800 mm	1800 mm
2000 mm	2000 mm

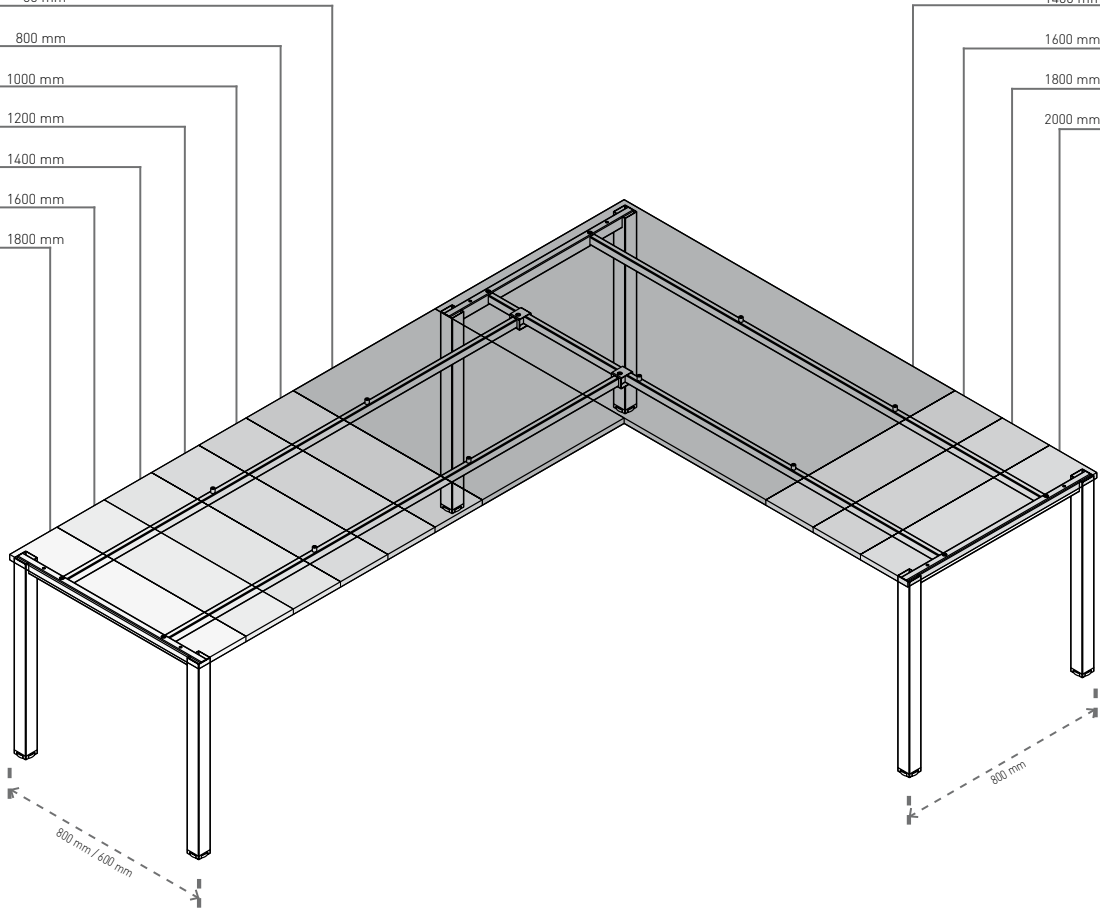

Telescopic connectors can be used with all other dimensions of table plates.

# SYSTEM DESK BAR



WATCH VIDEO

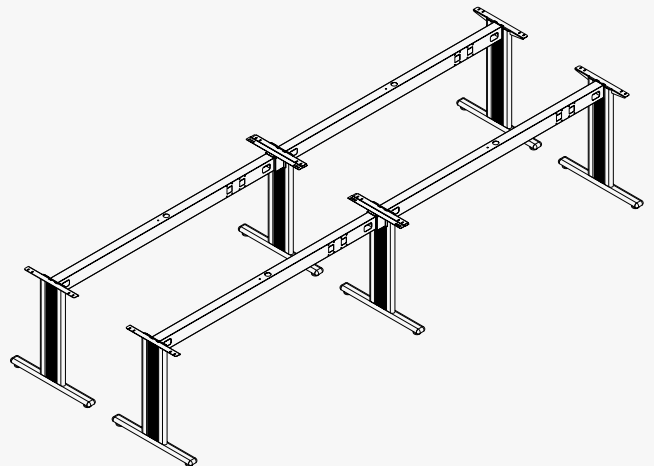
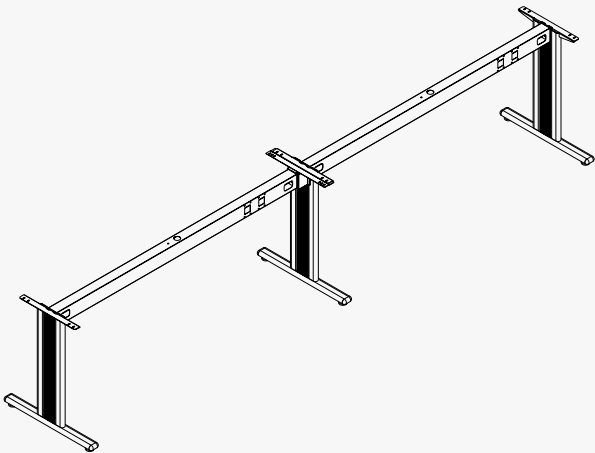
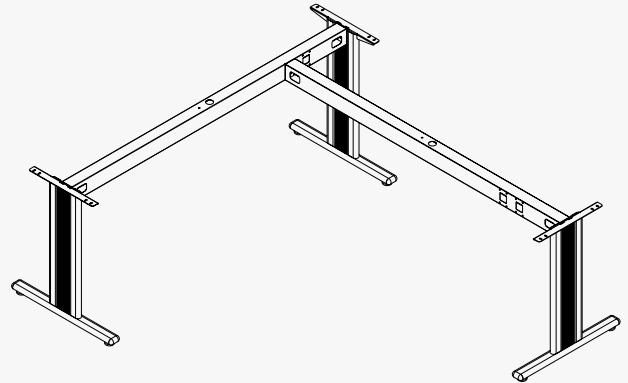
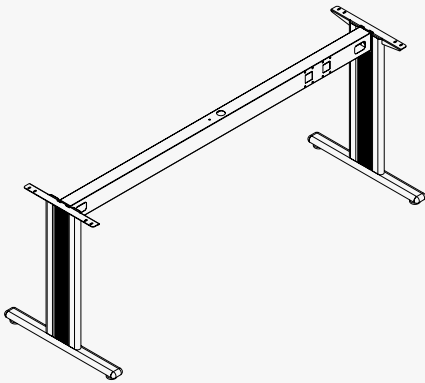

# TEMPO

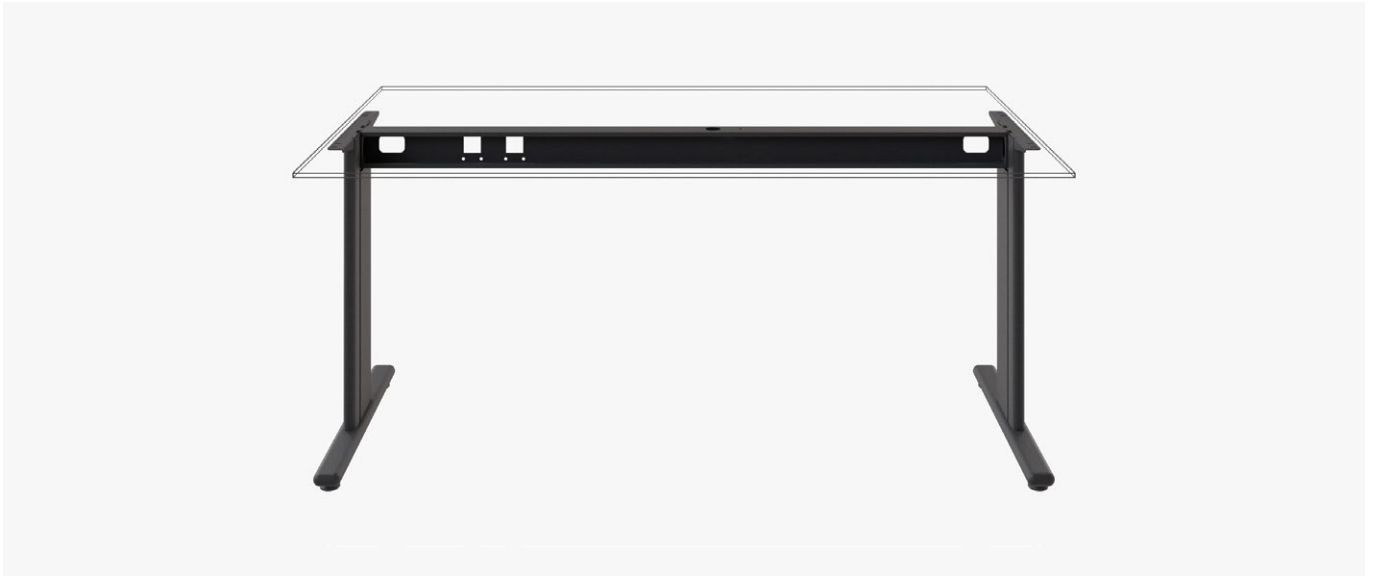

## TEMPO T 400

30002 | RAL 9006G  
20002 | RAL 9005FE

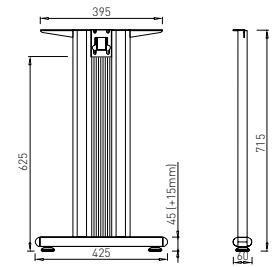
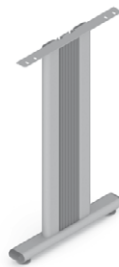

## TEMPO T 600

30000 | RAL 9006G  
20000 | RAL 9005FE

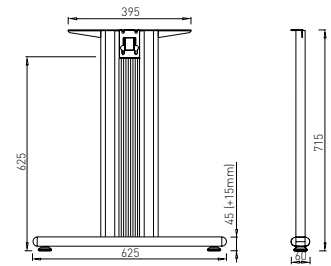

## TEMPO T 800

30006 | RAL 9006G  
20006 | RAL 9005FE

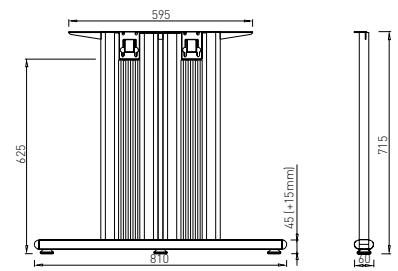

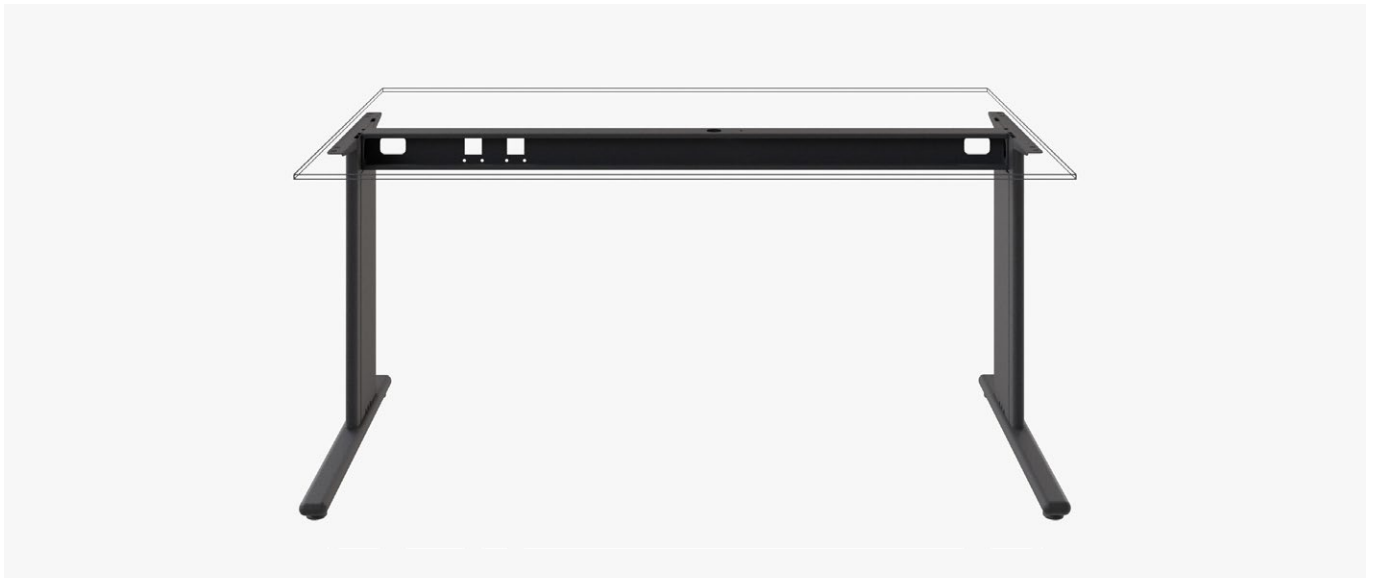

## COMO C 500

30143 | RAL 9006G  
20143 | RAL 9005FE

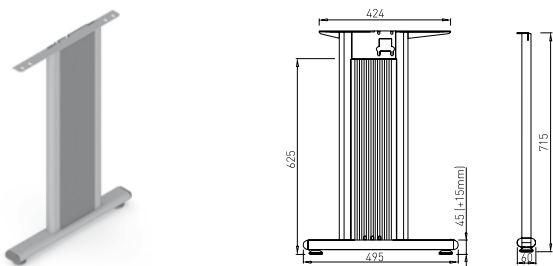

## COMO C 500 HV

30057 | RAL 9006G

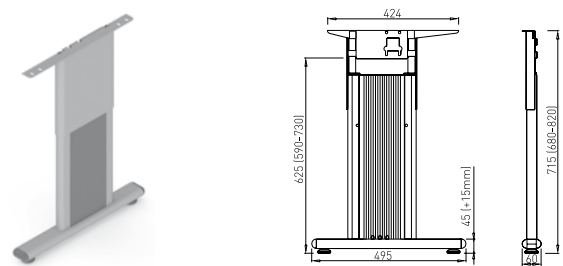

## COMO C 700

30145 | RAL 9006G  
20145 | RAL 9005FE

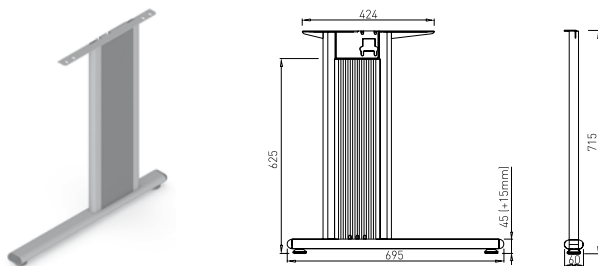

## COMO C 700 HV

30182 | RAL 9006G

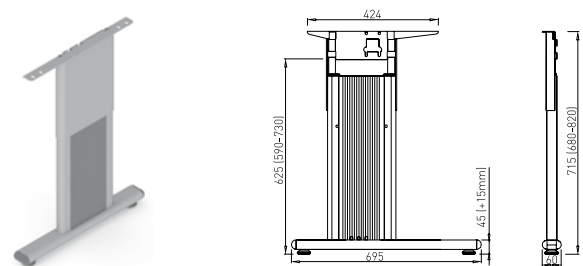

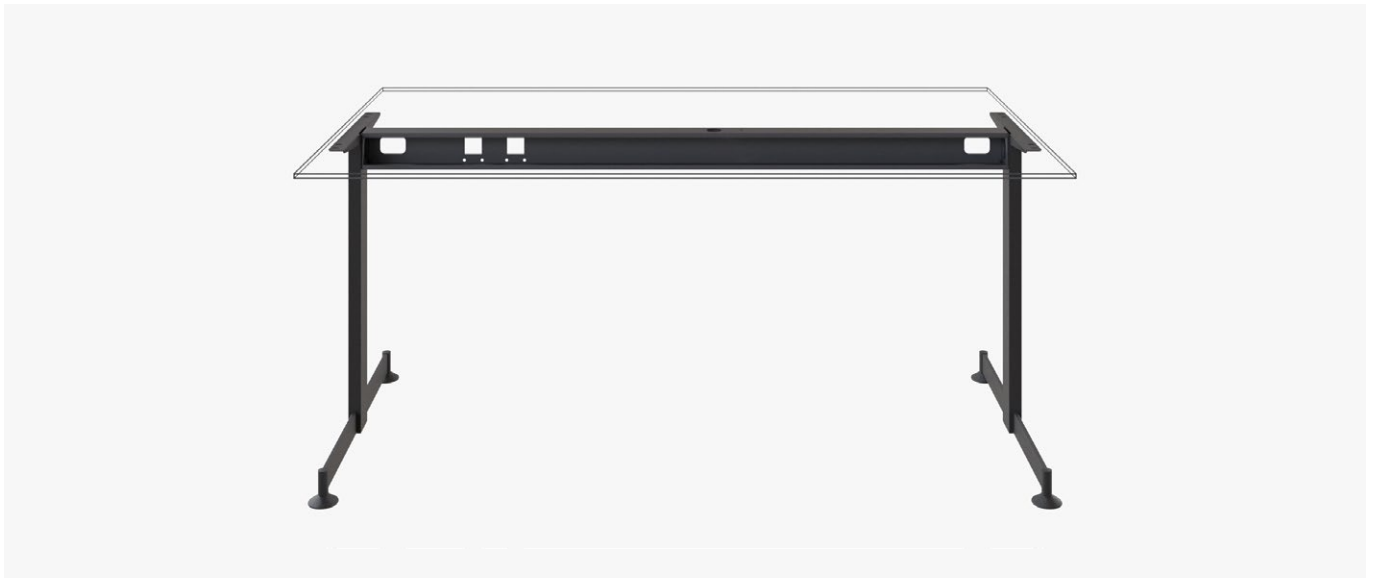

## TEND T 400

30745 | RAL 9006G  
20745 | RAL 9005FE

## TEND T 400 HV

30986 | RAL 9006G

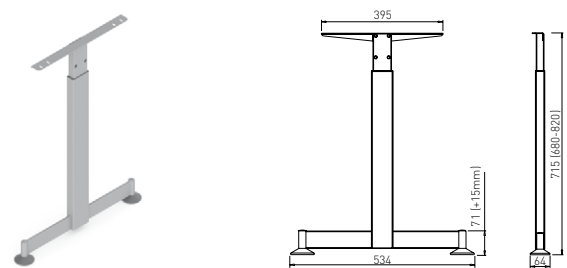
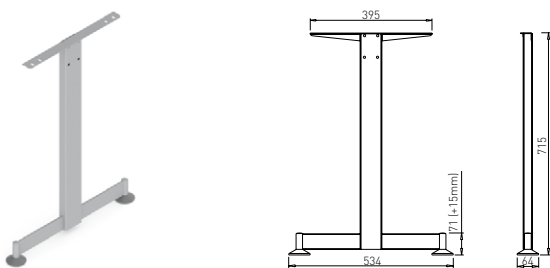

## TEND T 600

30744 | RAL 9006G  
20744 | RAL 9005FE

## TEND T 600 HV

30985 | RAL 9006G

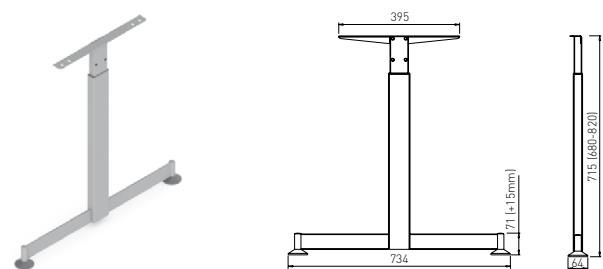
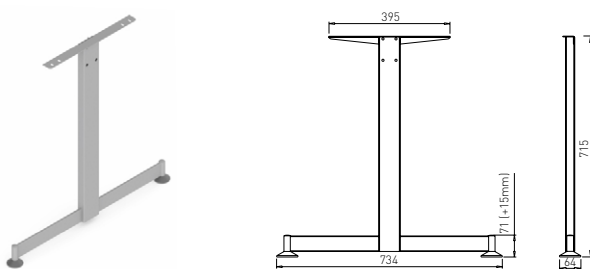



## TILL T 400

**31272** | RAL 9006G  
**21272** | RAL 9005FE

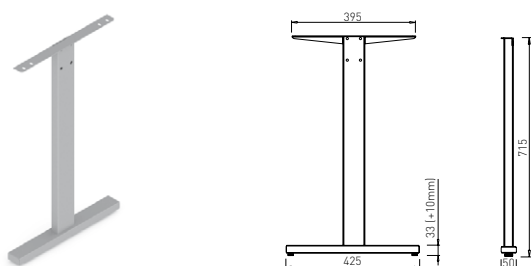

## TILL T 400 HV

**31274** | RAL 9006G

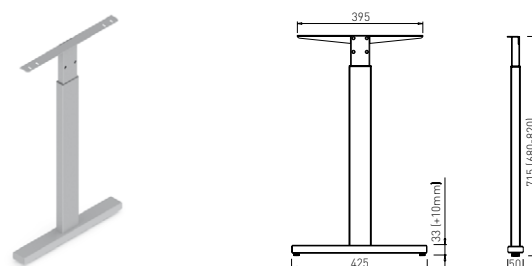

## TILL T 600

**31271** | RAL 9006G  
**21271** | RAL 9005FE

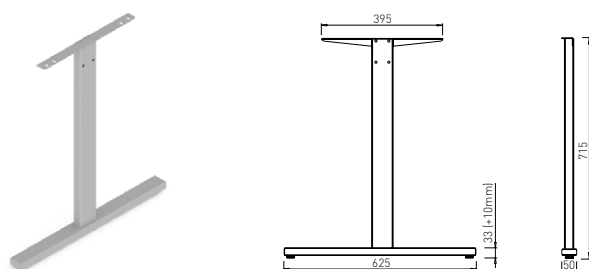

## TILL T 600 HV

**31273** | RAL 9006G

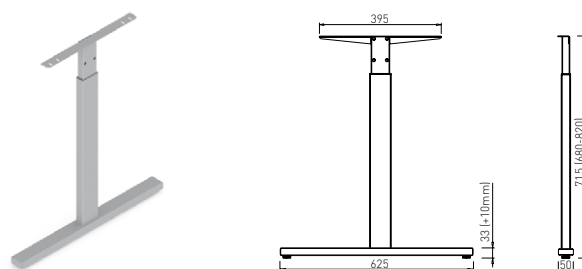

# MOST



## MOST

31270 | RAL 9006G  
21270 | RAL 9005FE

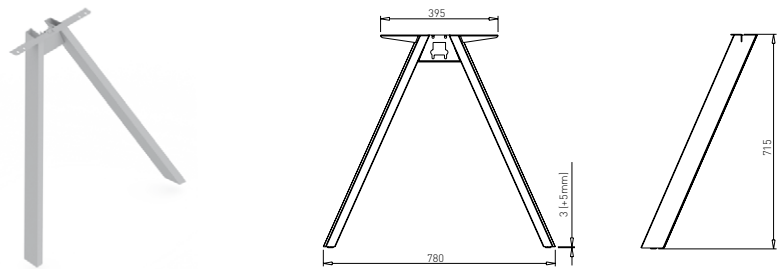

## EXAMPLE

Min. length of table plate 1400 -  
desk bar 800

Length of desk bar = length of  
table plate - 600 mm

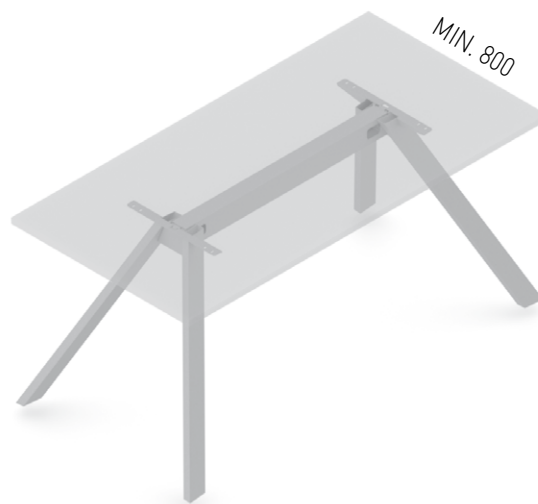

# TEEN

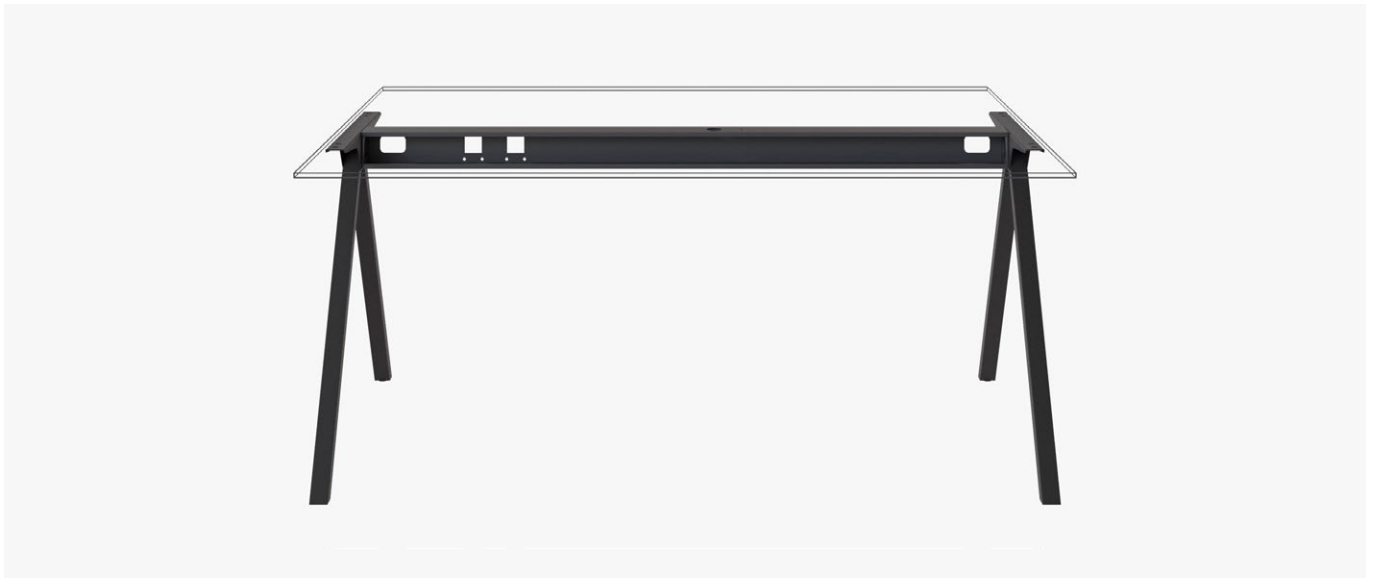

## TEEN

31520 | RAL 9006G

21520 | RAL 9005FE

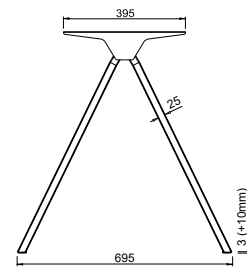

# TEEN BENCH



## TEEN BENCH

Product name	Length	RAL 9006G	RAL 9005FE
TEEN BENCH 1200	1200 mm	31324	21324
TEEN BENCH 1400	1400 mm	31322	21322
TEEN BENCH 1600	1600 mm	31323	21323

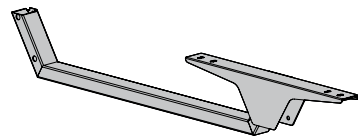

# CONNECTORS AND ACCESSORIES

## DESK BAR BASIC

Product name	Length	RAL 9006G	RAL 9005FE
DESK BAR 800	703 mm	30014	20014
DESK BAR 1000	903 mm	30015	20015
DESK BAR 1200	1103 mm	30017	20017
DESK BAR 1400	1303 mm	30019	20019
DESK BAR 1600	1503 mm	30021	20021
DESK BAR 1800	1703 mm	30022	20022
DESK BAR 2000	1903 mm	30023	20023

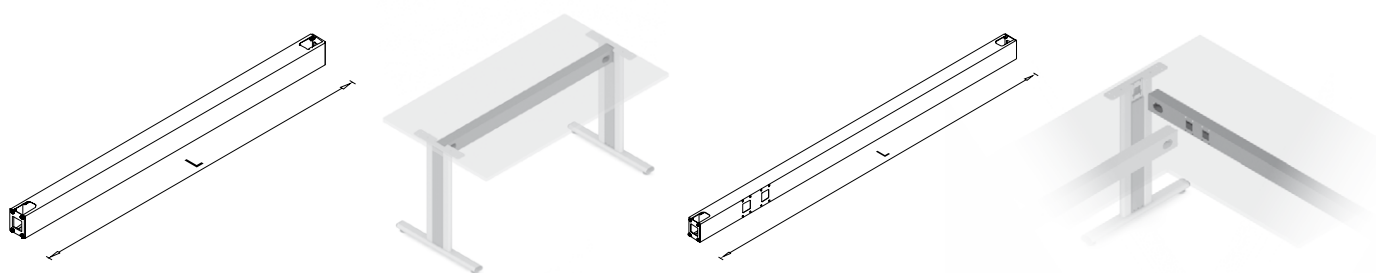

## DESK BAR TELESCOPIC

Product name	Length	RAL 9006G	RAL 9005FE
DESK BAR TELESCOPIC 1000–1600	903–1503 mm	31141	21141
DESK BAR TELESCOPIC 1400–2000	1303–1903 mm	31140	21140



---

## HOLDING PLATE 90°

30879 | RAL 9006G  
20879 | RAL 9005FE

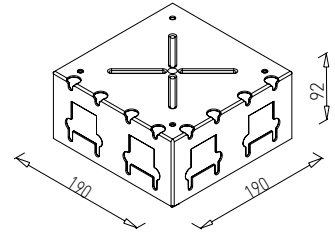
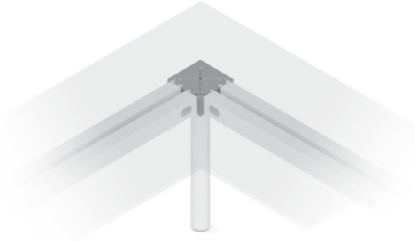

---

## LEG HOLDER

30076 | RAL 9006G  
20076 | RAL 9005FE

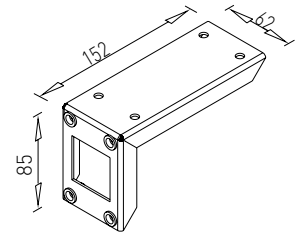
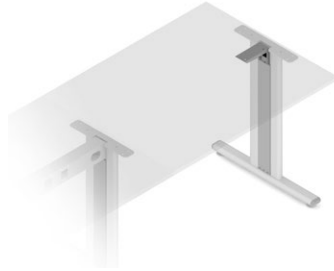

---

## DESK BAR EXTENSION

30394 | RAL 9006G  
20394 | RAL 9005FE

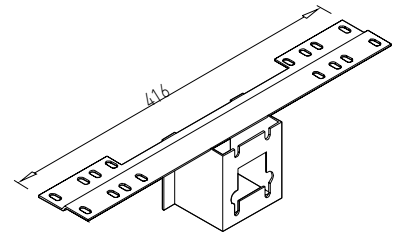

---

## CONNECTING PLATE Z

30024 | RAL 9006G  
20024 | RAL 9005FE

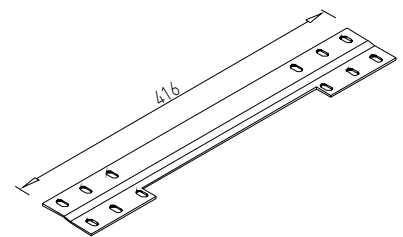
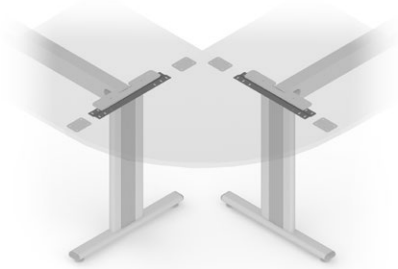

---

## CONNECTING PLATE 90x65

30027 | RAL 9006G  
20027 | RAL 9005FE

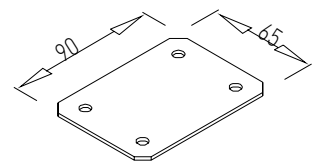

---

## HOLDER

30901 | RAL 9006G  
20901 | RAL 9005FE

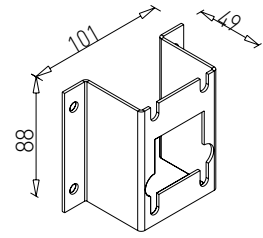
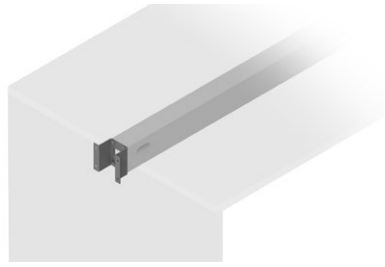

---

## COMPUTER SHELF

30056 | RAL 9006G  
20056 | RAL 9005FE

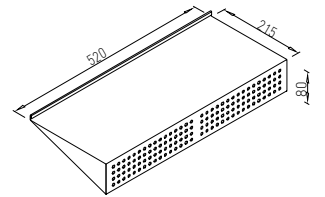

# ANGULAR SOLUTIONS 90°

For T-legs TEMPO, TEND, WORK and TILL

## DESK BAR - 400 mm = table plate dimension

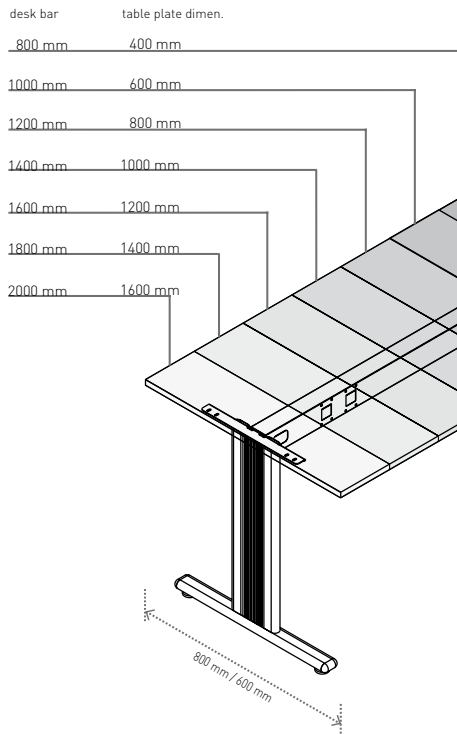

## DESK BAR = table plate dimension

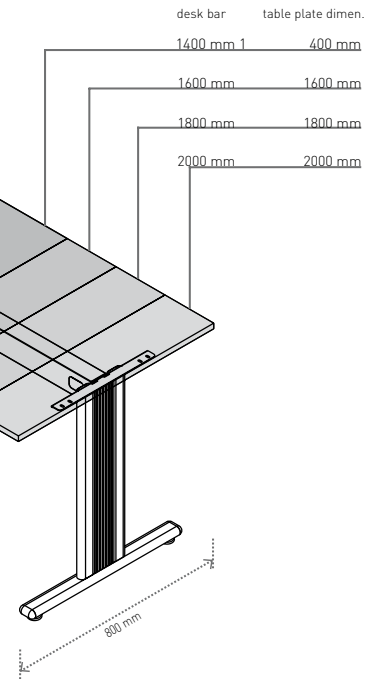

## DESK BAR - 400 mm = table plate dimension

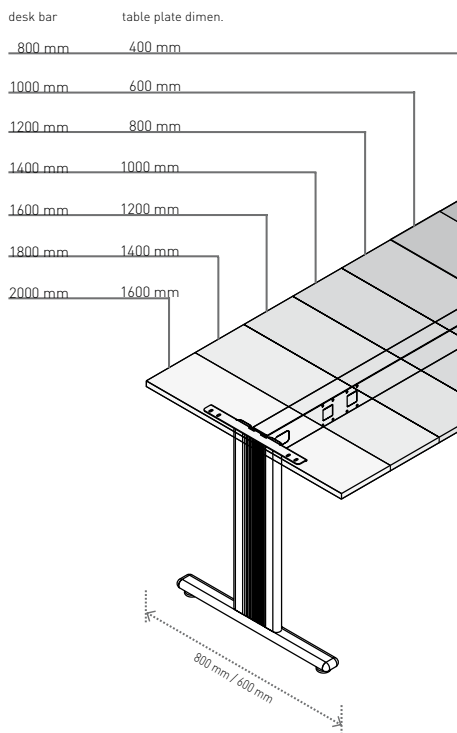

## DESK BAR + 400 mm = table plate dimension

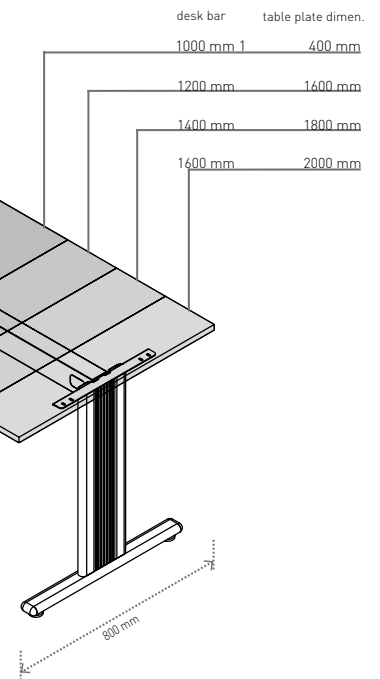

# ANGULAR SOLUTIONS 90°

For C-legs COMO and MARK

## DESK BAR - 500 mm = table plate dimension

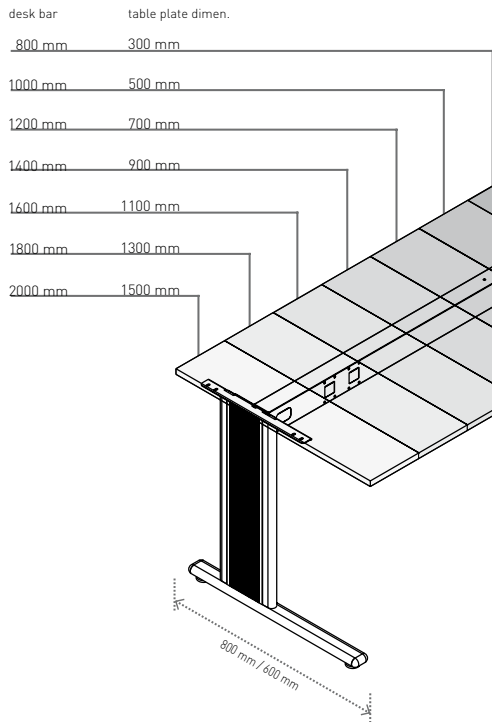

## DESK BAR = table plate dimension

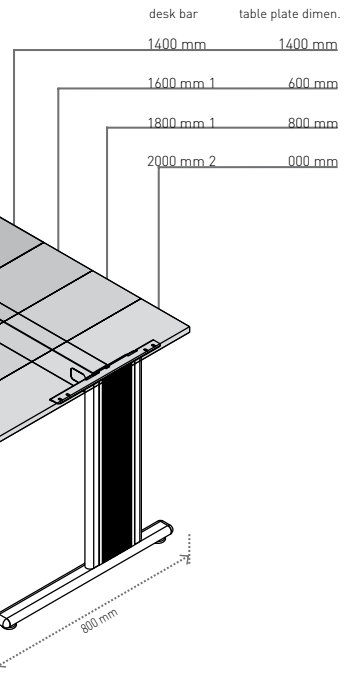

## DESK BAR - 400 mm = table plate dimension

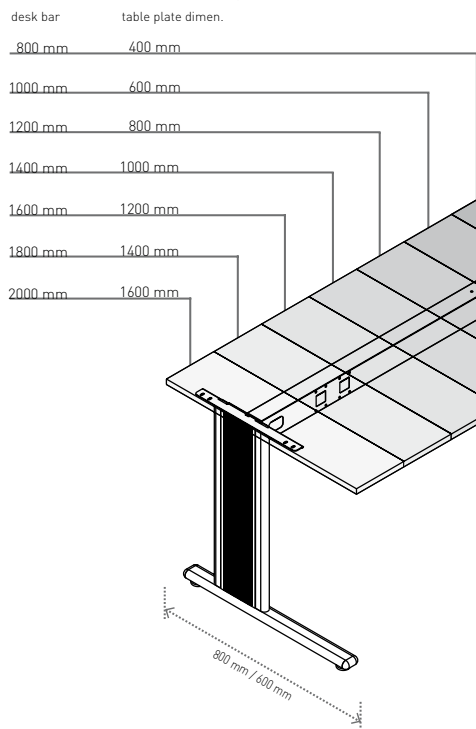

## DESK BAR + 400 mm = table plate dimension

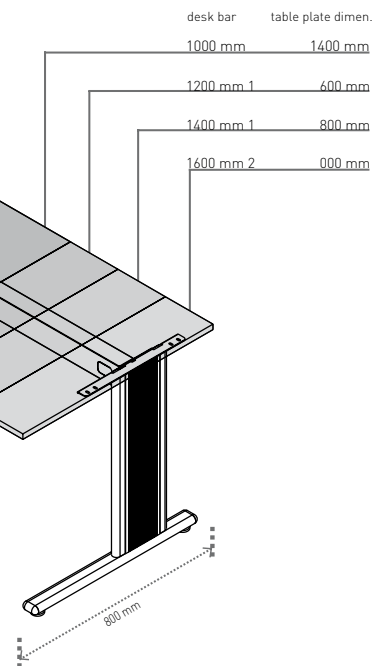

# SYSTEM EDGE



WATCH VIDEO

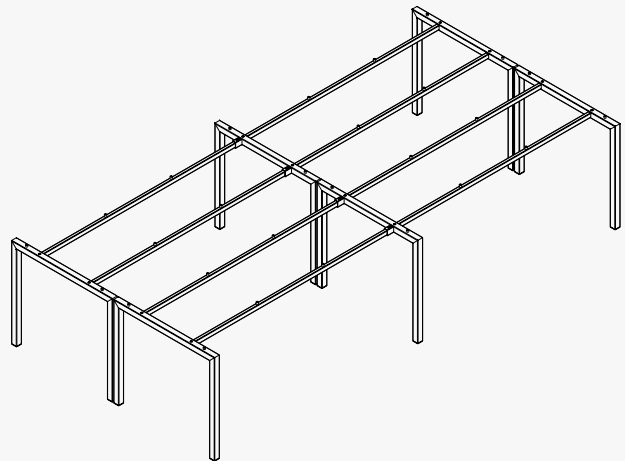
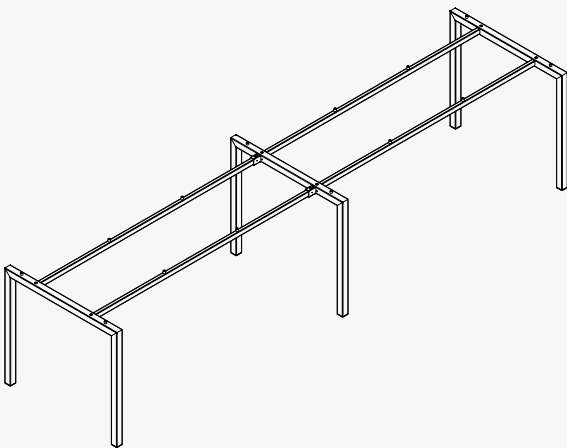
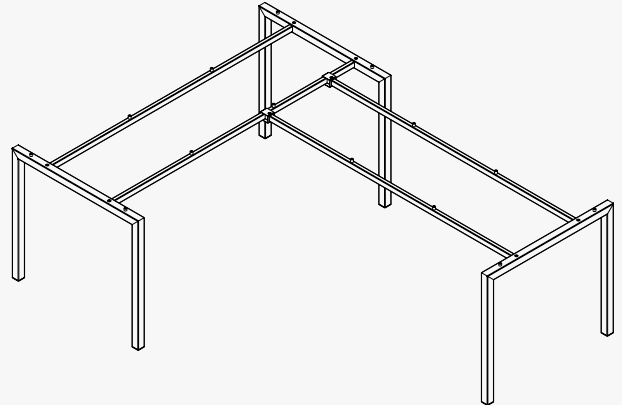
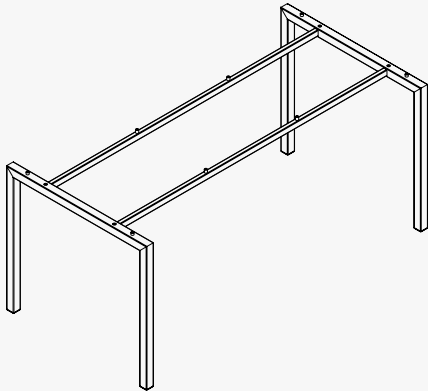

# HAVANA



## HAVANA 40/600

31428 | RAL 9006G

21428 | RAL 9005FE

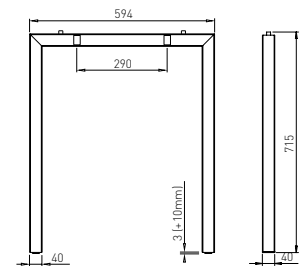

## HAVANA 40/800

31429 | RAL 9006G

21429 | RAL 9005FE

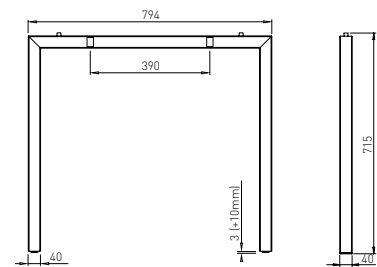

## HEIGHT-ADJUSTABLE PLUG CUBO 40

30702 | RAL 7015 plastic

20702 | RAL 9005 plastic

Two plug sets are required for one leg.  
Using the plugs, the height of the table  
can be adjusted from 736 to 856 mm.

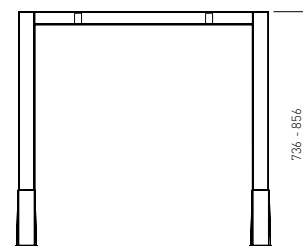
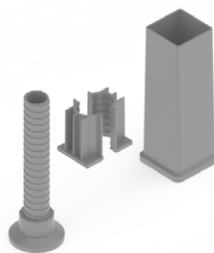

# FLAT

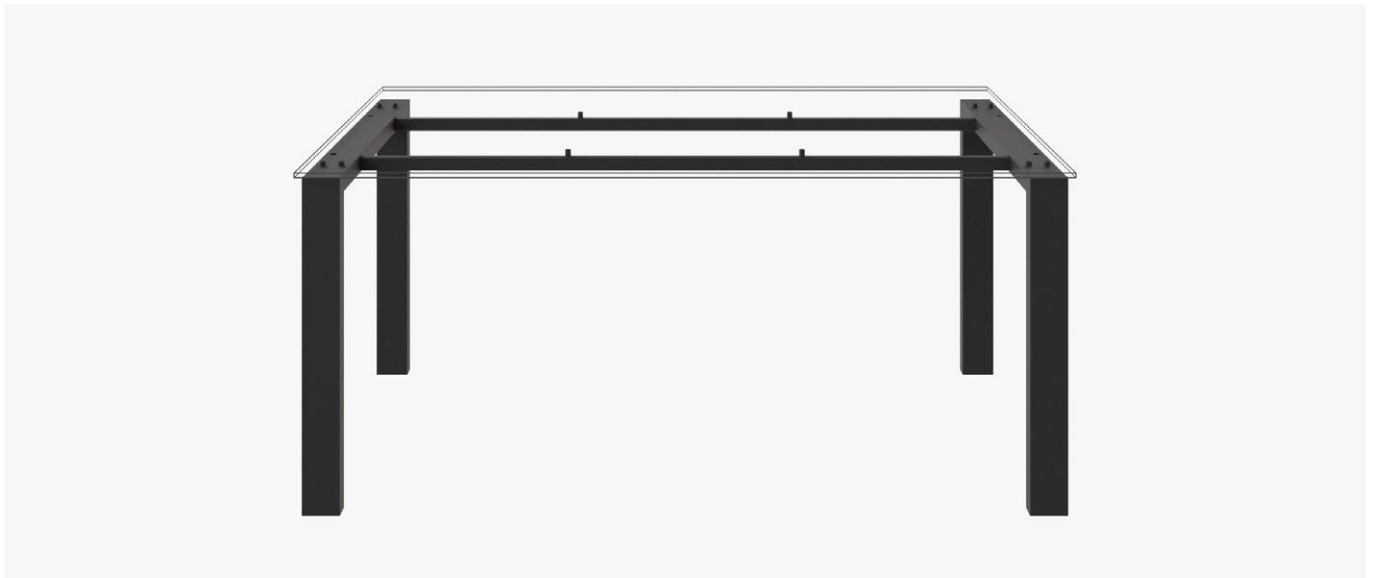

## FLAT 600

31489 | RAL 9006G  
21489 | RAL 9005FE

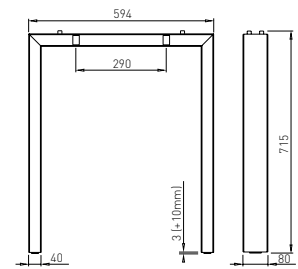

## FLAT 800

31490 | RAL 9006G  
21490 | RAL 9005FE

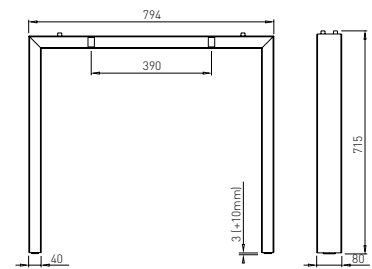

# CONNECTORS AND ACCESSORIES

## CONNECTORS EDGE

Product name	Length	RAL 9006G	RAL 9005FE
Connector 600	590 mm	30831	20831
Connector 800	790 mm	30832	20832
Connector 1000	990 mm	30833	20833
Connector 1200	1190 mm	30834	20834
Connector 1400	1390 mm	30835	20835
Connector 1600	1590 mm	30836	20836
Connector 1800	1790 mm	30837	20837
Connector 2000	1990 mm	30838	20838

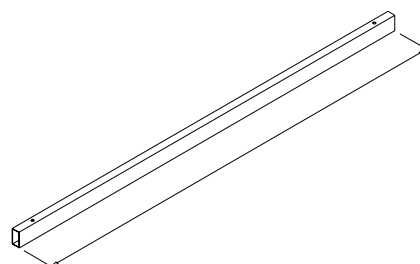
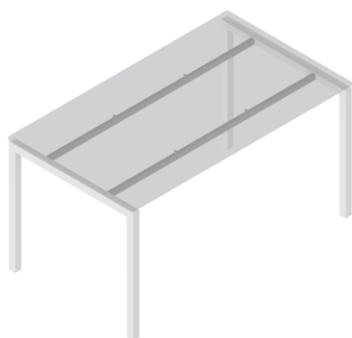

## CONNECTORS EDGE TELESCOPIC

Product name	RAL 9006G	RAL 9005FE
Connector 900–1400	31491	21491
Connector 1500–2000	31492	21492

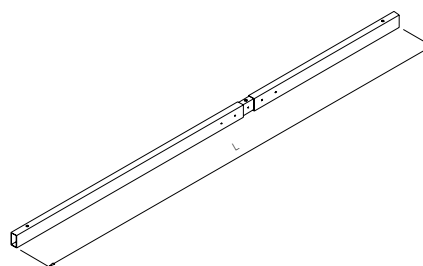
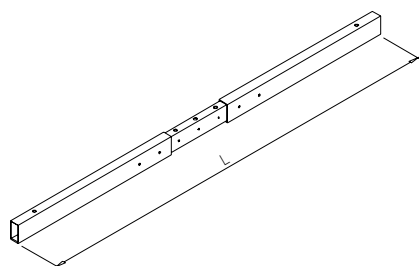

---

## CORNER CONNECTOR EDGE

31437 | RAL 9006G

21437 | RAL 9005FE

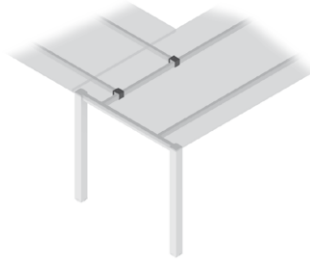

2 X

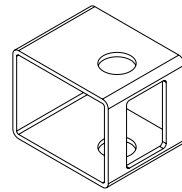

---

## CONNECTING EXTENSION EDGE

31493 | RAL 9006G

21493 | RAL 9005FE

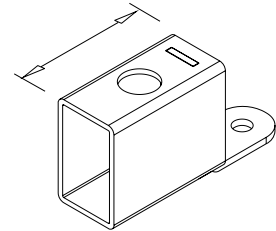
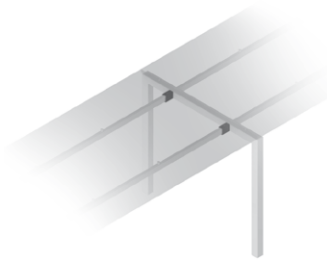

---

## SUPPORTER EDGE

31497 | RAL 9006G

21497 | RAL 9005FE

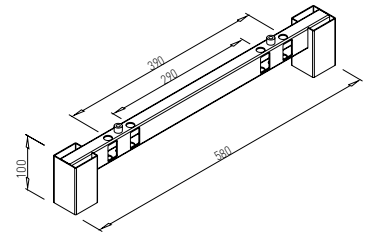
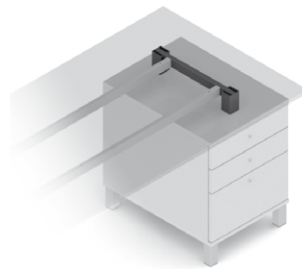

---

## COMPUTER HOLDER

30846 | RAL 9006G

20846 | RAL 9005FE

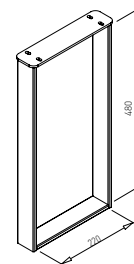

---

## WIRE SHELF

31498 | RAL 9006G

21498 | RAL 9005FE

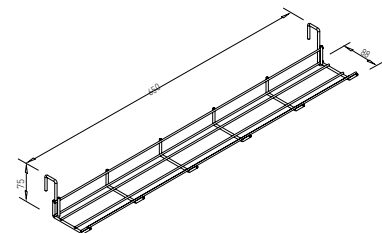
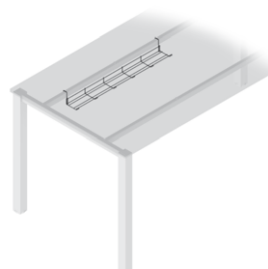

# ANGULAR SOLUTION

For legs from system EDGE

**connector - 200 mm = table plate dimension**

connector	table plate dimen.
800 mm	600 mm
1000 mm	800 mm
1200 mm	1000 mm
1400 mm	1200 mm
1600 mm	1400 mm
1800 mm	1600 mm
2000 mm	1800 mm

**connector = table plate dimension**

connector	table plate dimen
1400 mm	1400 mm
1600 mm	1600 mm
1800 mm	1800 mm
2000 mm	2000 mm

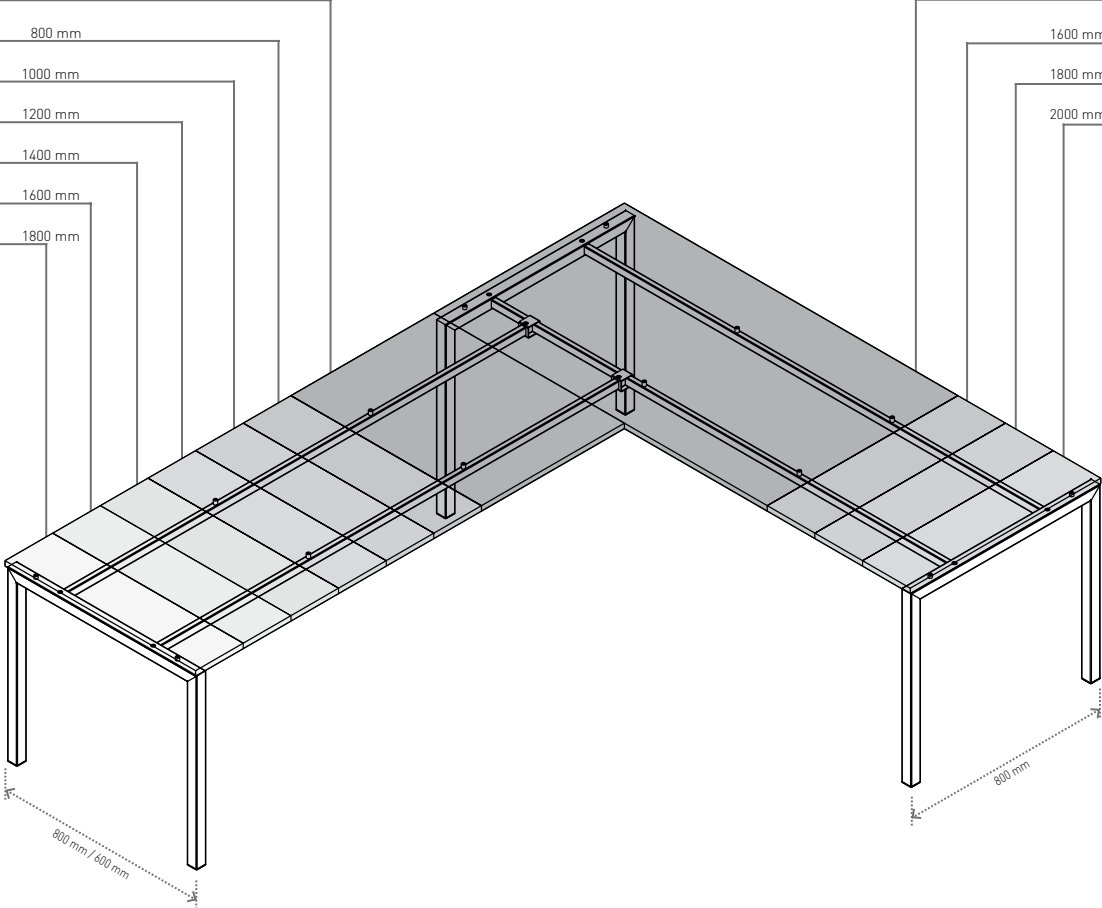

Telescopic connectors can be used with all other dimensions of table plates.

# SYSTEM KOTA



WATCH VIDEO

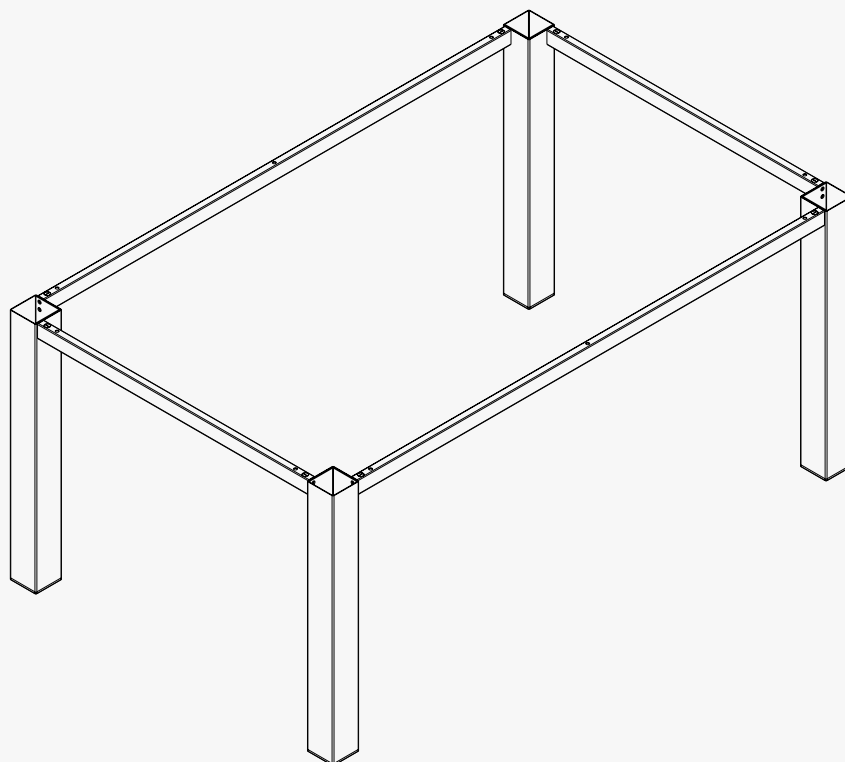

# KOTA



## KOTA 80x80

30900 | RAL 9006G

20900 | RAL 9005FE

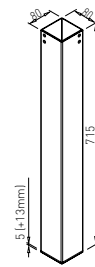

# KOTA



## KOTA ø80

31376 | RAL 9006G

21376 | RAL 9005FE



## CONNECTORS KOTA

Product name	Length	RAL 9006G	RAL 9005FE
Connector KOTA 600	430 mm	<b>30923</b>	<b>20923</b>
Connector KOTA 800	630 mm	<b>31377</b>	<b>21377</b>
Connector KOTA 900	730 mm	<b>31378</b>	<b>21378</b>
Connector KOTA 1000	830 mm	<b>31379</b>	<b>21379</b>
Connector KOTA 1200	1030 mm	<b>31380</b>	<b>21380</b>
Connector KOTA 1400	1230 mm	<b>31381</b>	<b>21381</b>
Connector KOTA 1600	1430 mm	<b>31382</b>	<b>21382</b>
Connector KOTA 1800	1630 mm	<b>31383</b>	<b>21383</b>
Connector KOTA 2000	1830 mm	<b>31384</b>	<b>21384</b>

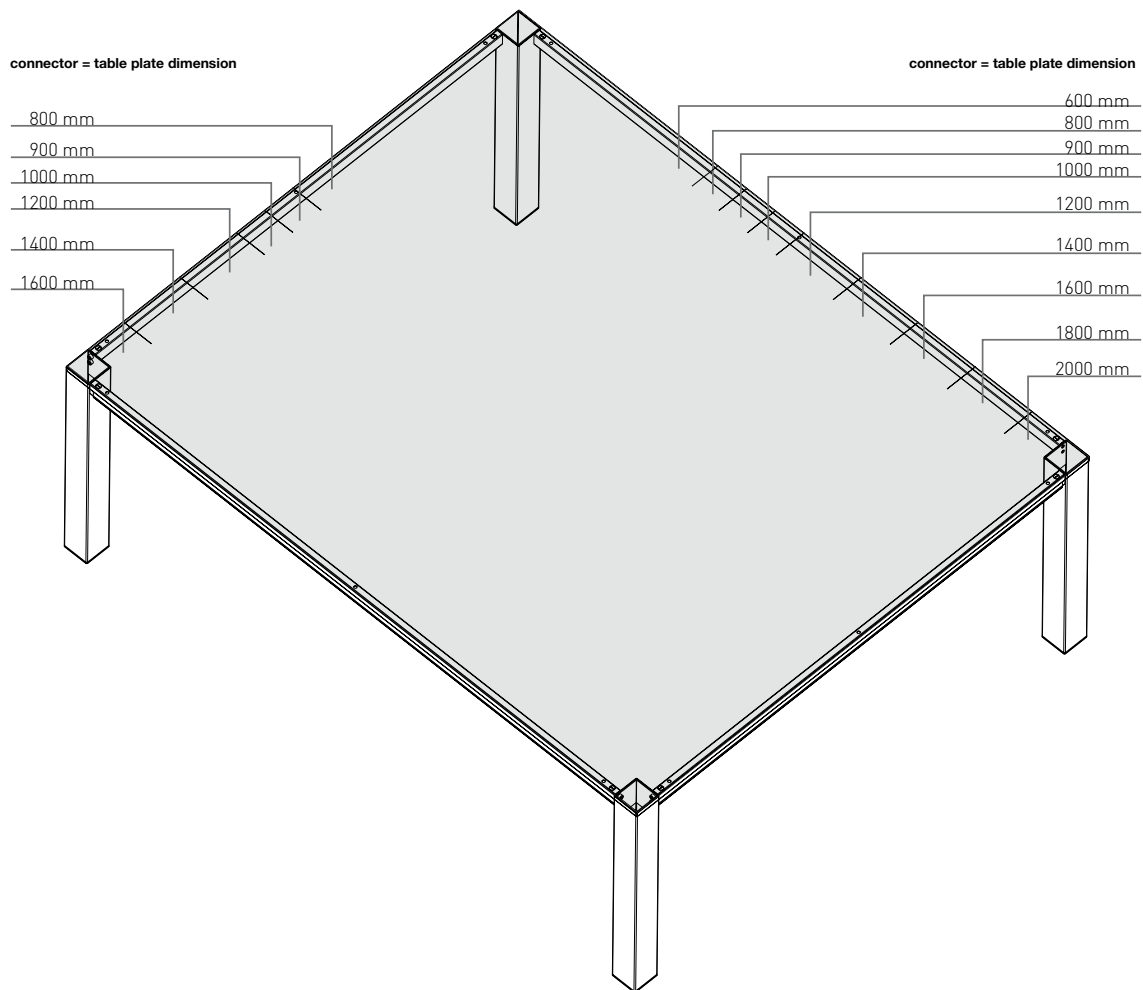

# SYSTEM SOLO



WATCH VIDEO

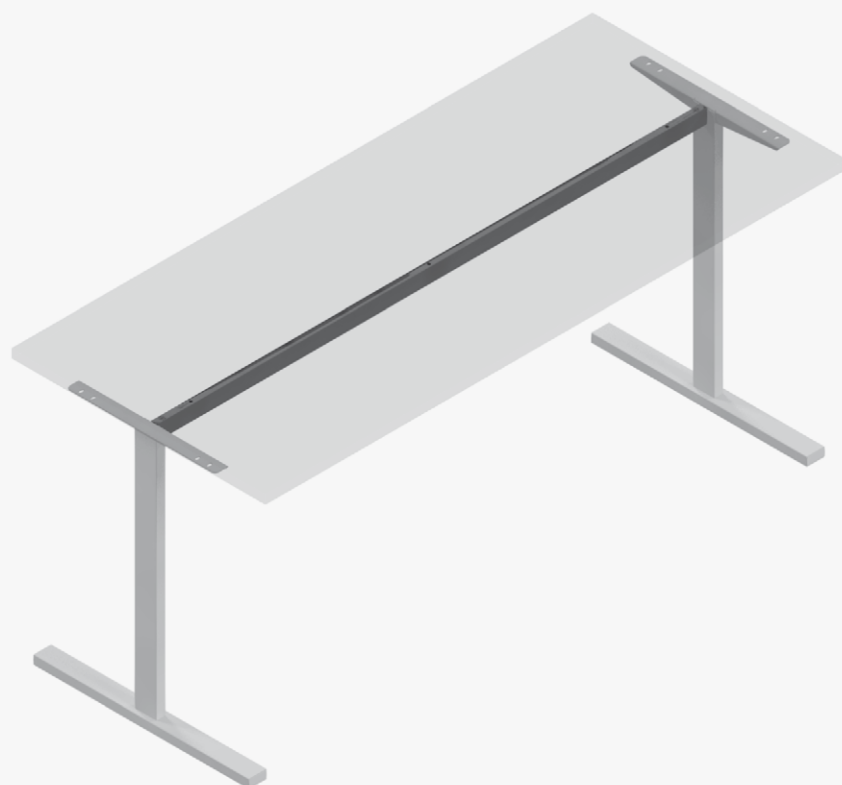

# SOLO ARCH

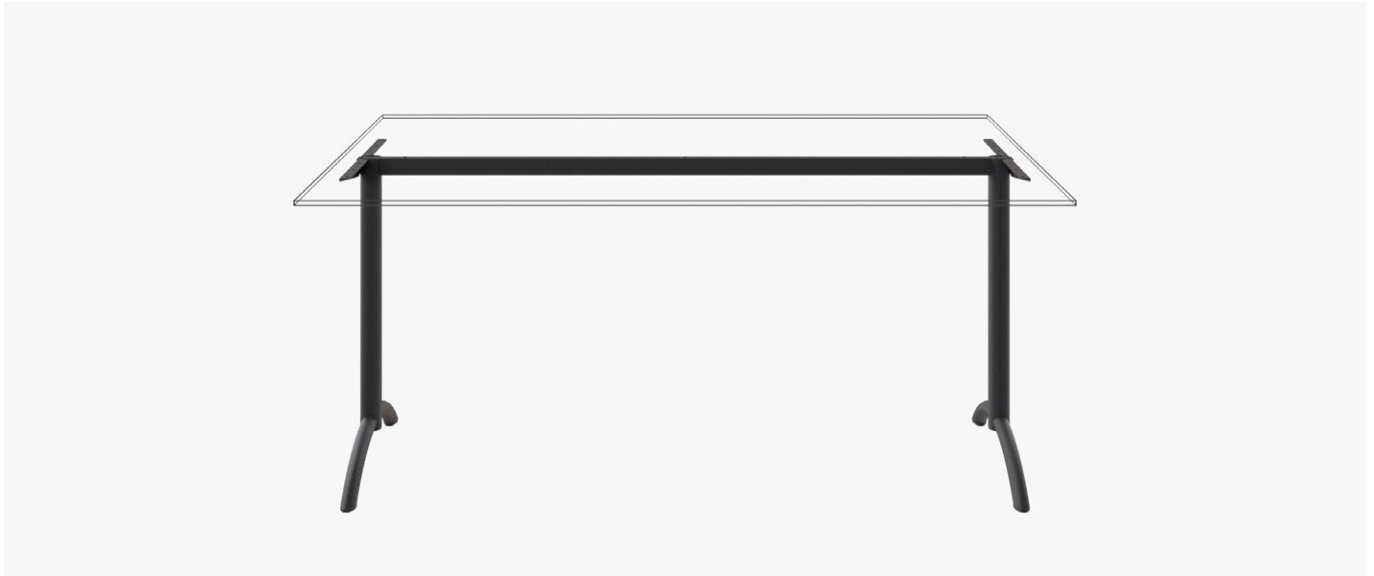

SOLO ARCH

30793 | RAL 9006G

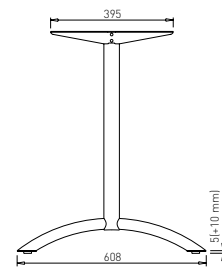

# SOLO SIMPLE

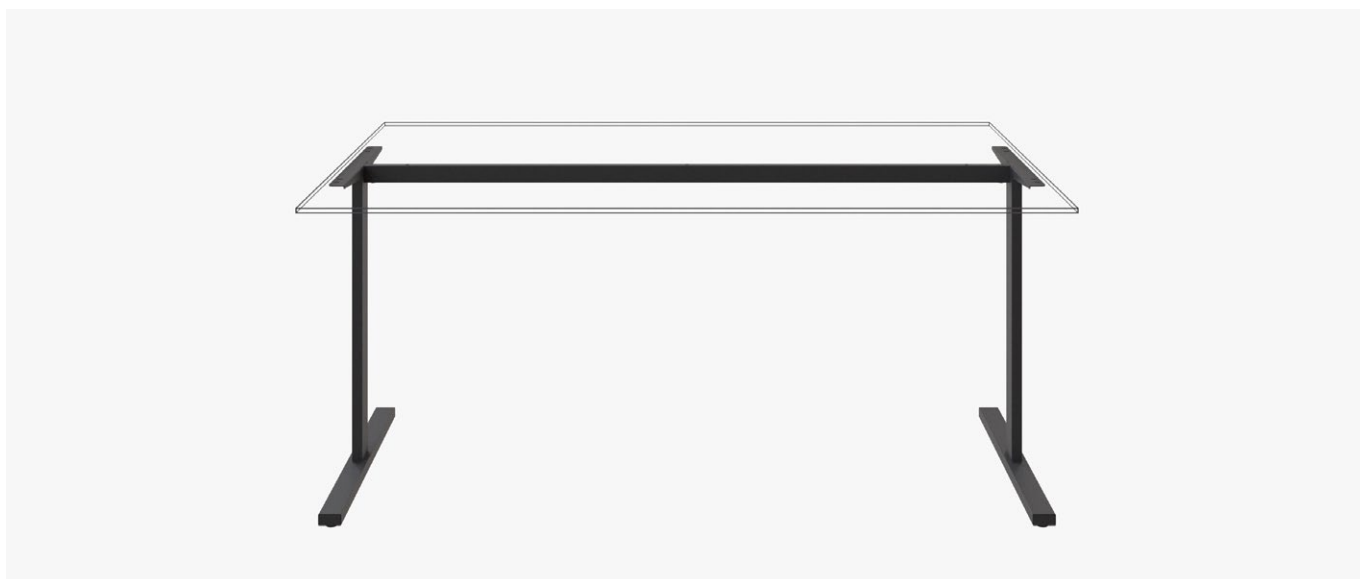

SOLO SIMPLE

30792 | RAL 9006G

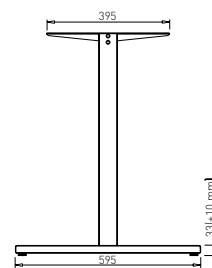

## CONNECTORS SOLO

Product name	Length	RAL 9006G
Connector SOLO 800	710 mm	30818
Connector SOLO 1000	910 mm	30819
Connector SOLO 1200	1110 mm	30816
Connector SOLO 1400	1310 mm	30814
Connector SOLO 1600	1510 mm	30815
Connector SOLO 1800	1710 mm	30974
Connector SOLO 2000	1910 mm	30126

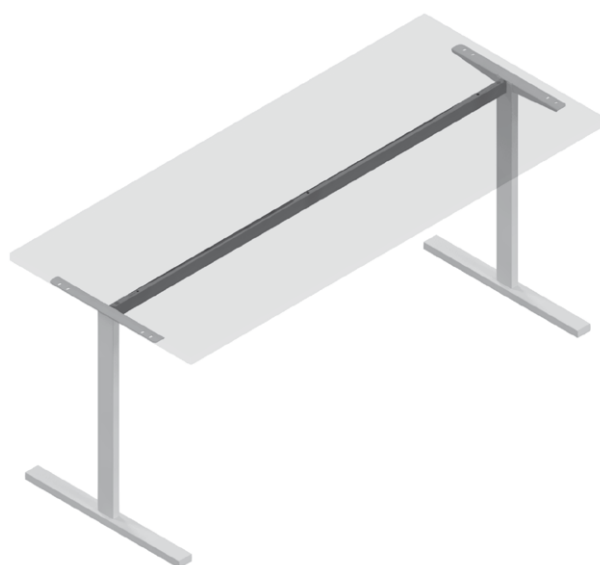

# SYSTEM BACK



WATCH VIDEO

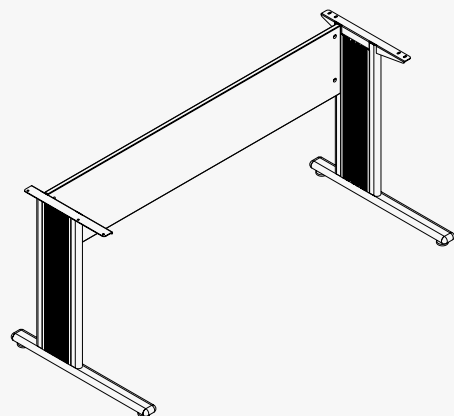
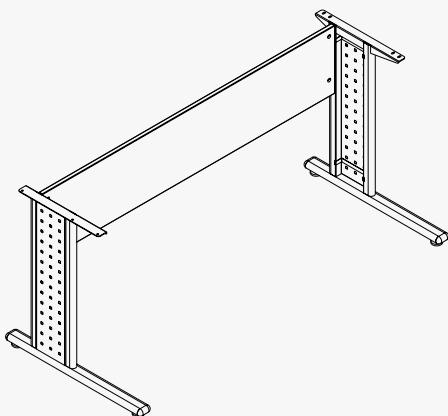
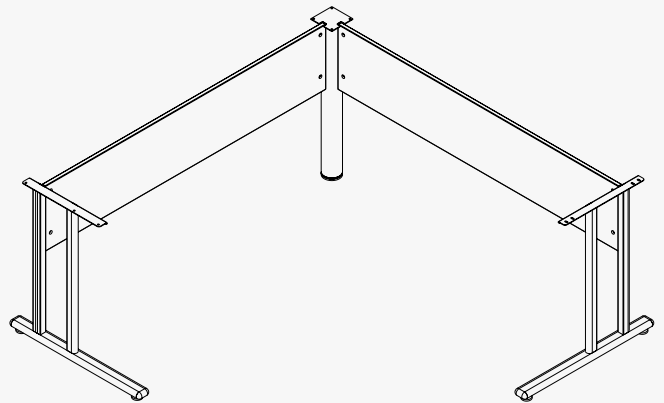
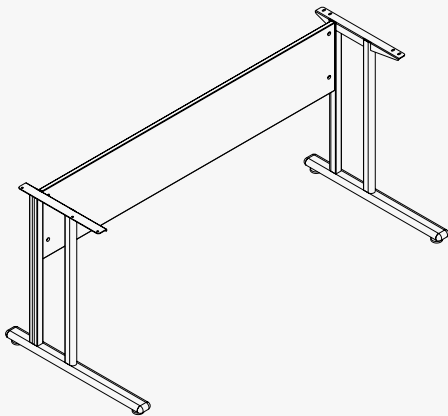

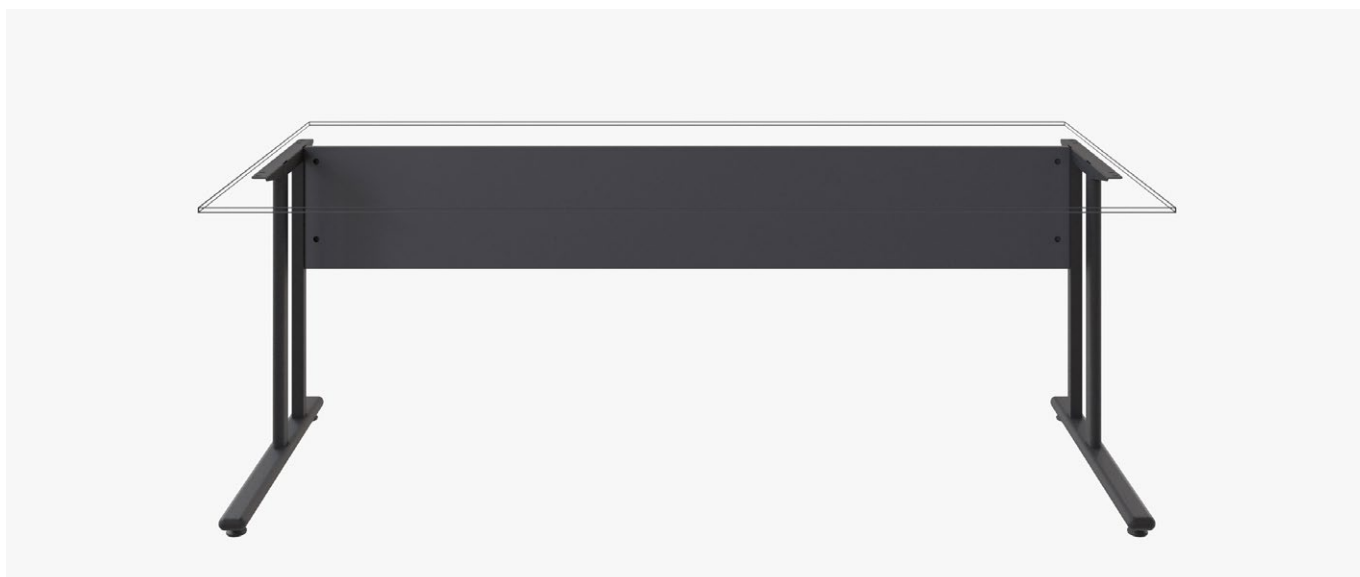

## AVA C 500

30173 | RAL 9006G  
20173 | RAL 9005FE

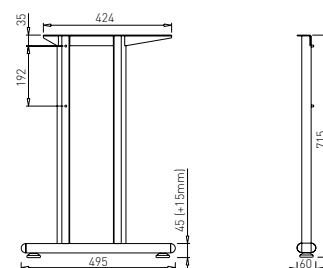

## AVA C 700

30172 | RAL 9006G  
20172 | RAL 9005FE

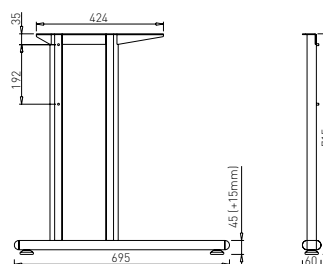

## AVA CC 800

30251 | RAL 9006G  
20251 | RAL 9005FE

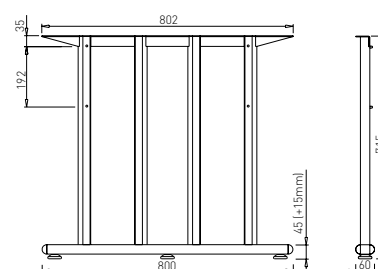

## CORNER LEG $\varnothing 80/90^\circ$

30174 | RAL 9006G

20174 | RAL 9005FE

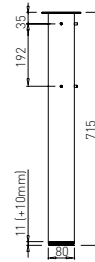

## METAL INSET

30220 | RAL 9006G

20220 | RAL 9005FE

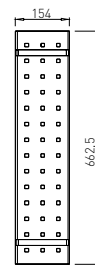
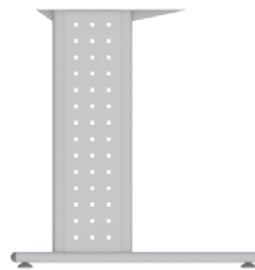

## PLASTIC INSET

30219 | RAL 7015 plastic

20219 | RAL 9005 plastic

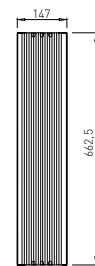

## PLAN FOR WOODEN BACK MANUFACTURE

X = dimension of the table  
plate - 110 mm

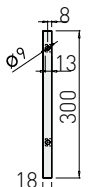
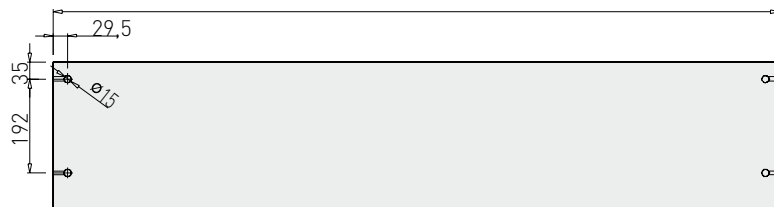

# SELF-STANDING LEGS



Table top thickness minimum 25 mm



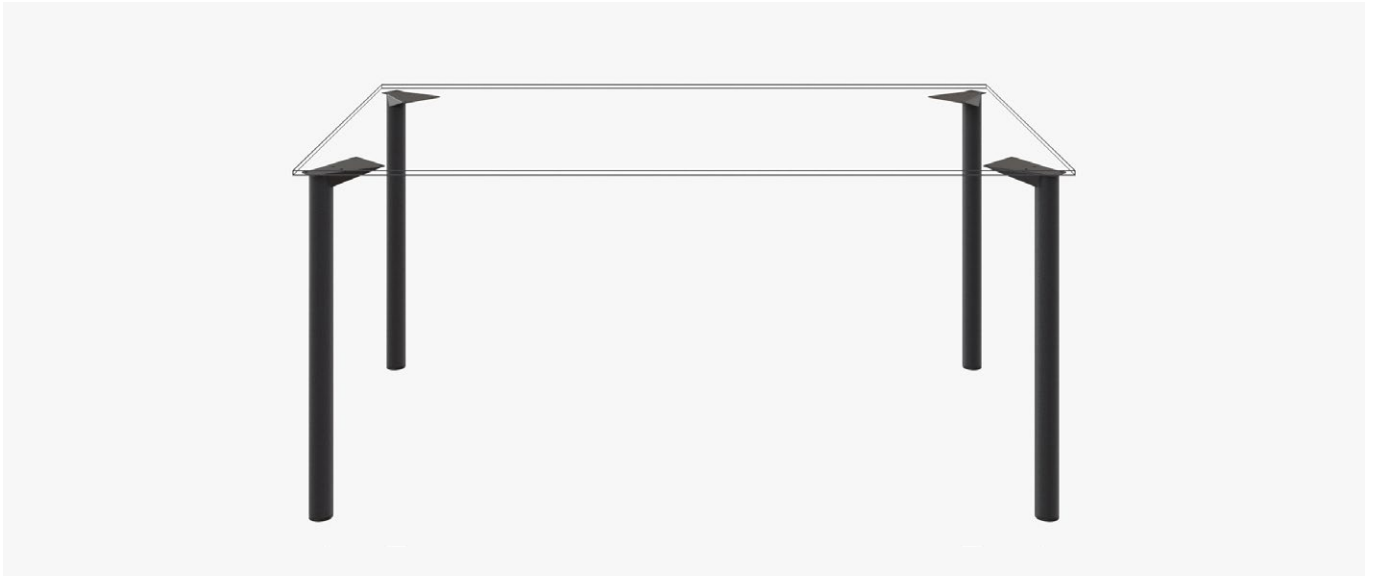

## FIFTY

30052 | RAL 9006G  
20052 | RAL 9005FE

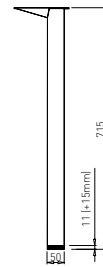

## FIFTY K

30055 | RAL 9006G

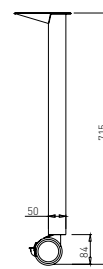

## PLUG OXO/HV

30704 | RAL 7015 plastic  
20704 | RAL 9005 plastic

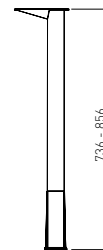
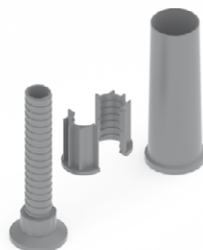

# CUB-IN

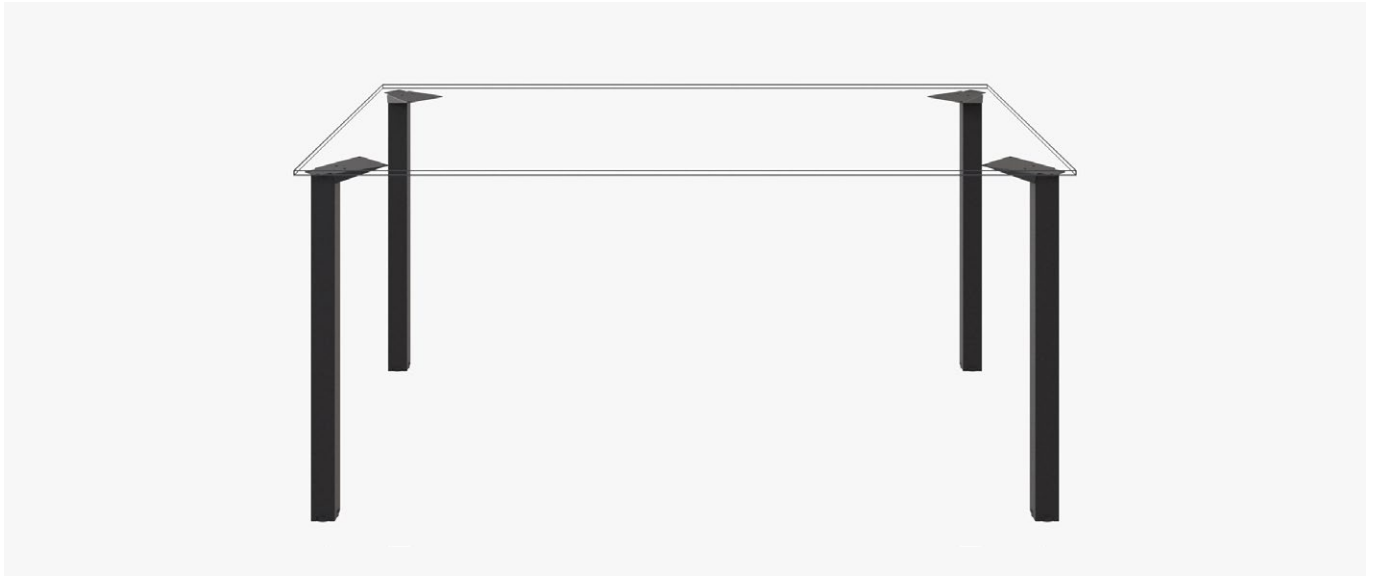

## CUB-IN

30385 | RAL 9006G  
20385 | RAL 9005FE



## CUB-IN K

30387 | RAL 9006G

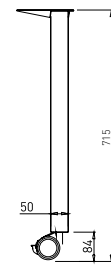

## PLUG CUBO/HV

30709 | RAL 7015 plastic  
20709 | RAL 9005 plastic

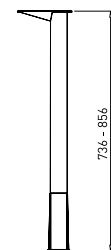
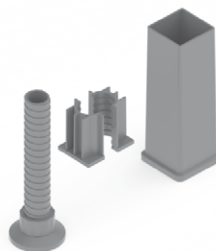

# SIXTY

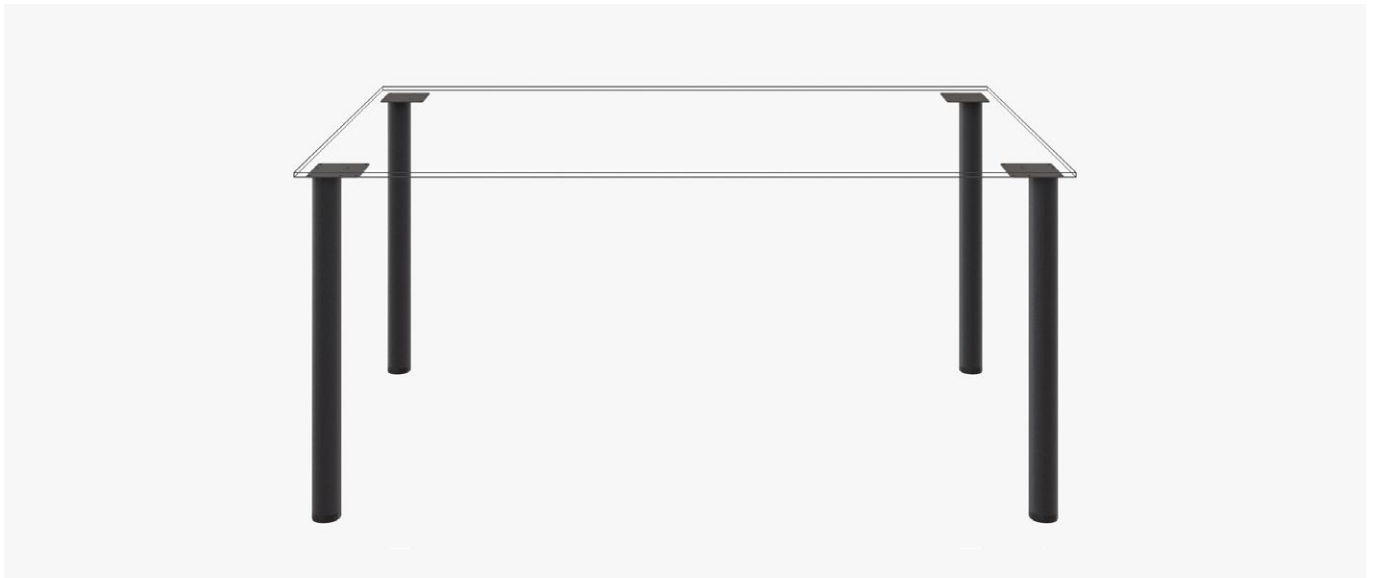

## SIXTY

30012 | RAL 9006G  
20012 | RAL 9005FE



## SIXTY K

30018 | RAL 9006G



## SIXTY CLUB

30398 | RAL 9006G

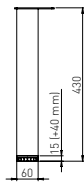

## SIXTY BAR

30132 | RAL 9006G  
20132 | RAL 9005FE

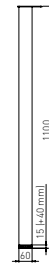

# EIGHTY

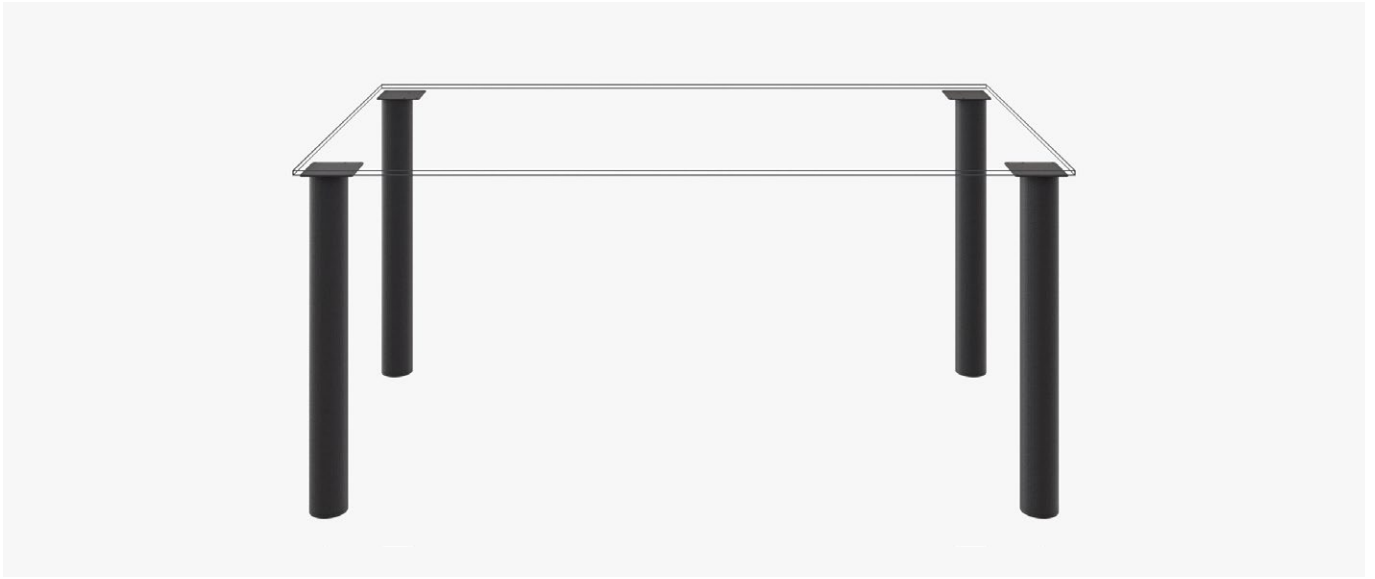

## EIGHTY

30080 | RAL 9006G

20080 | RAL 9005FE



# ROMB

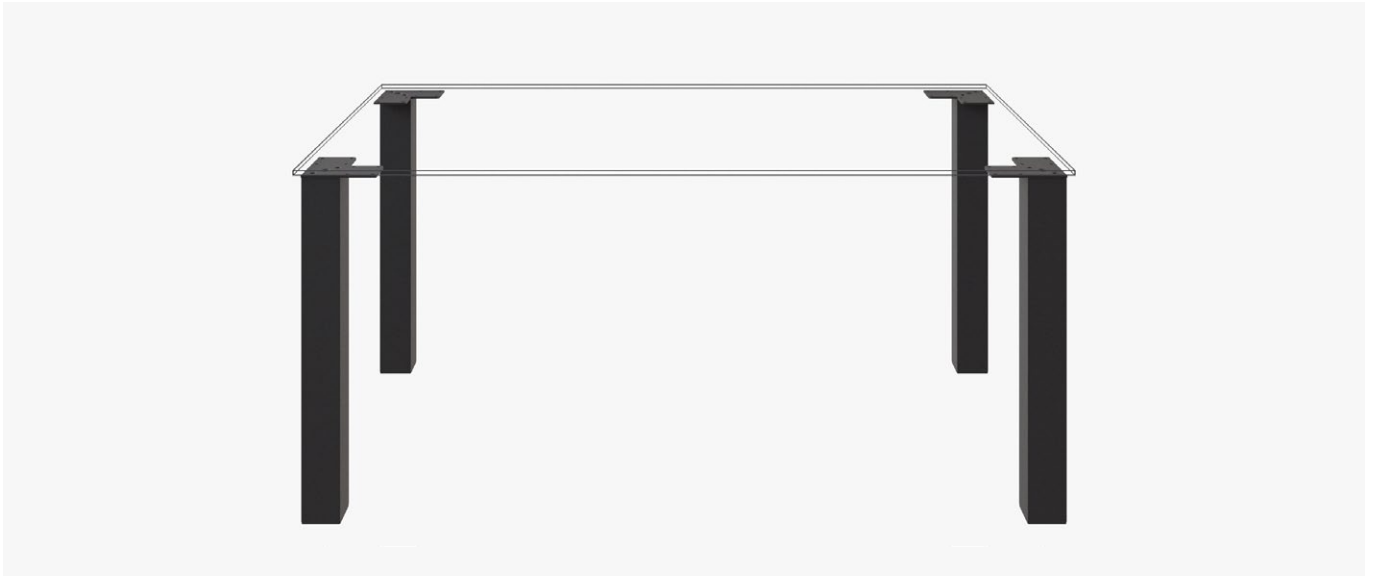

## ROMB 50

30896 | RAL 9006G  
20896 | RAL 9005FE

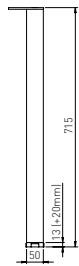

## ROMB 50 CLUB

30897 | RAL 9006G  
20897 | RAL 9005FE

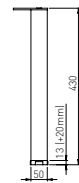

## ROMB 80

30973 | RAL 9006G  
20973 | RAL 9005FE



## ROMB 80 CLUB

31266 | RAL 9006G  
21266 | RAL 9005FE



# PARK Z

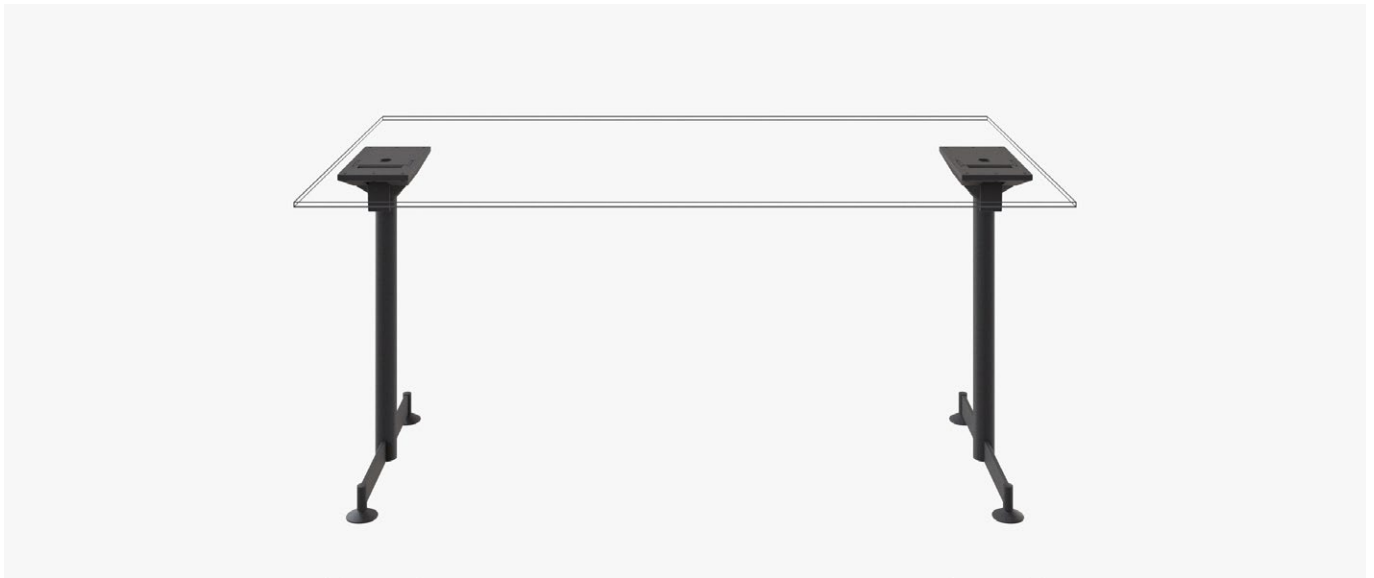

## PARK Z

30848 | RAL 9006G

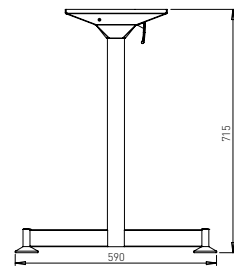

## PARK Z with wheels

31253 | RAL 9006G

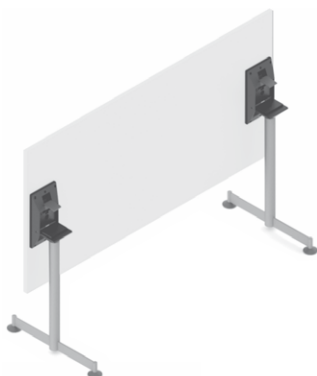
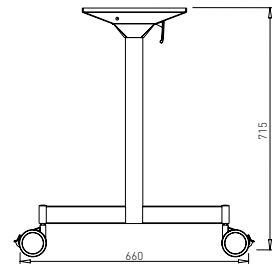

# FIFTY Z

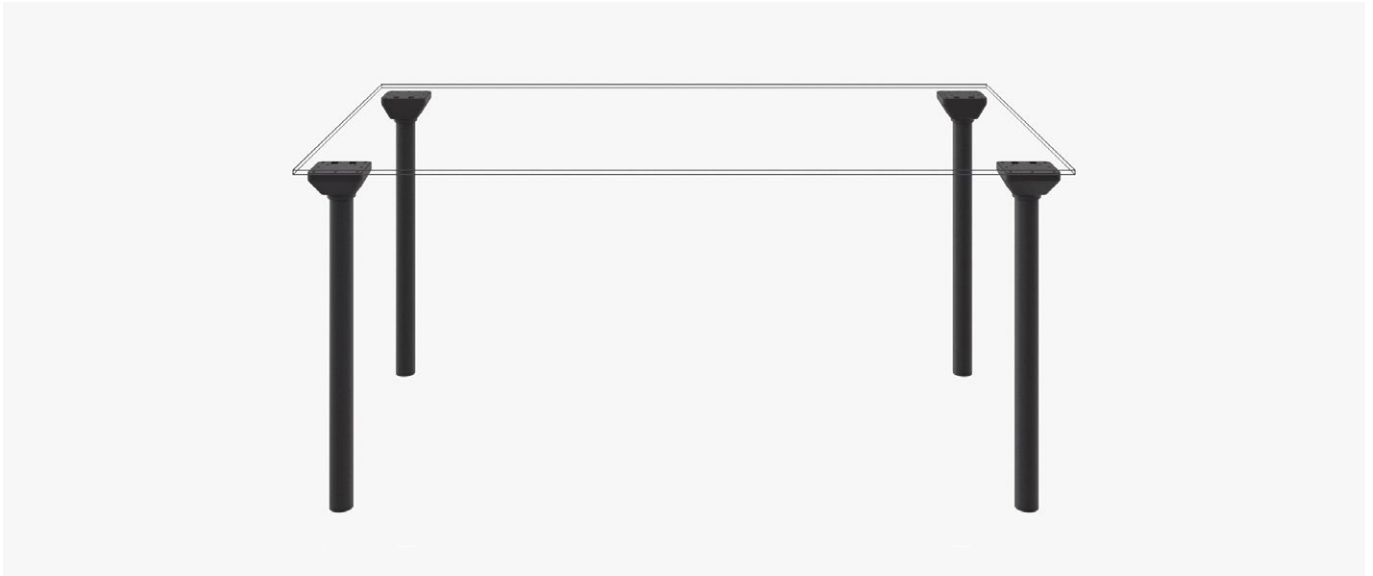

## FIFTY Z

30736 | RAL 9006G

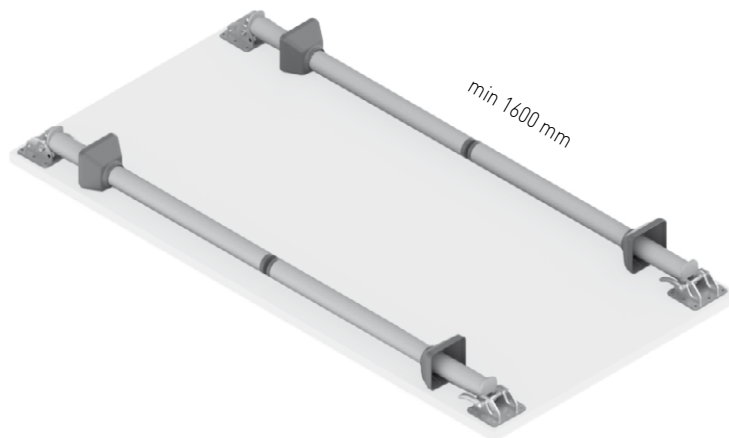

# SKIP

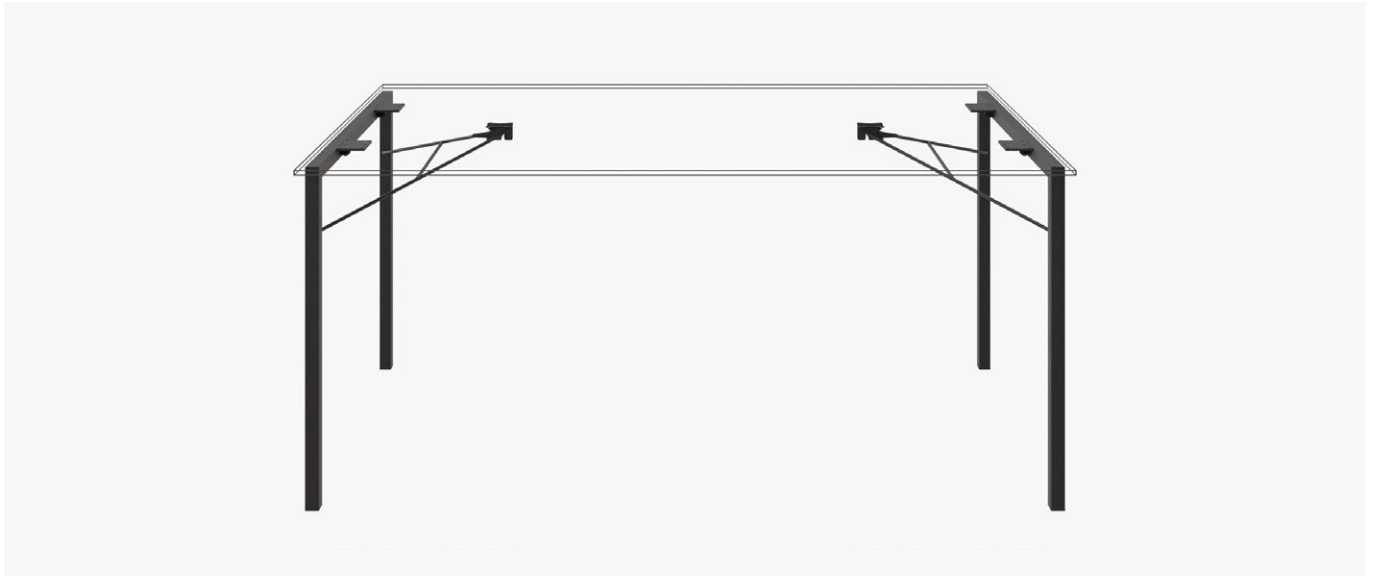

## SKIP 800

31269 | RAL 9006G

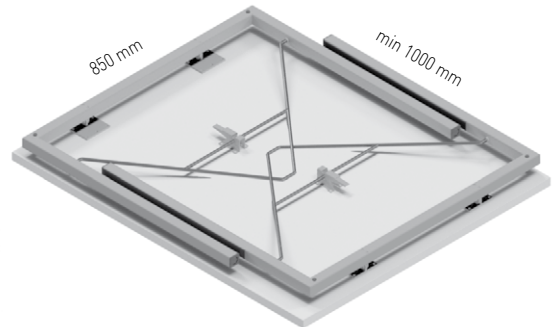
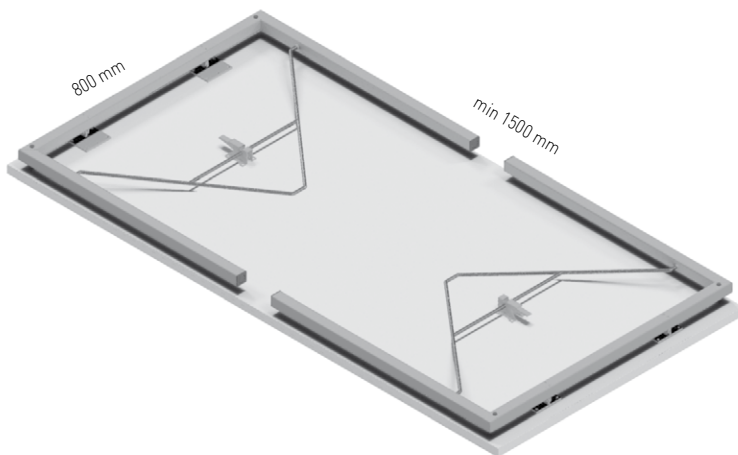
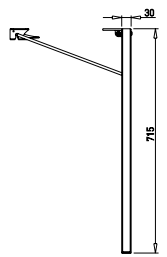
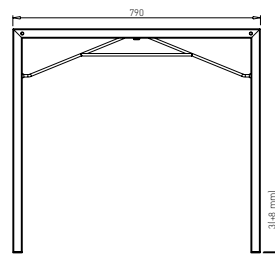

# A-LEG



## A-LEG

30654 | RAL 9006G  
20654 | RAL 9005FE

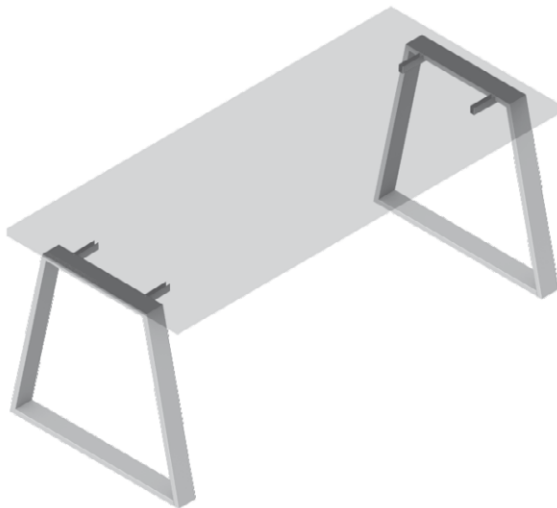
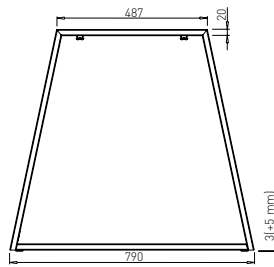

# U-LEG



## U-LEG

30655 | RAL 9006G

20655 | RAL 9005FE

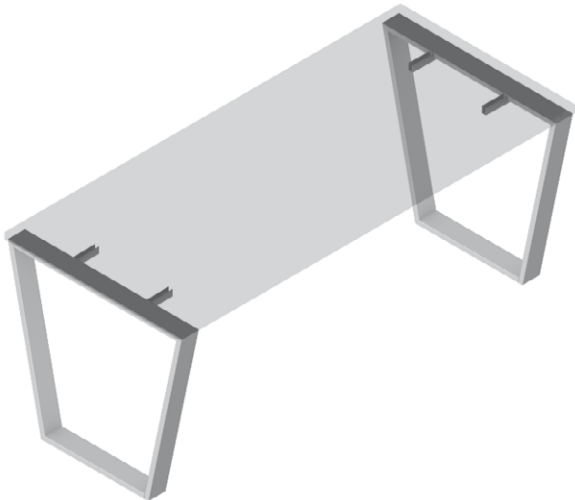
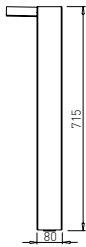
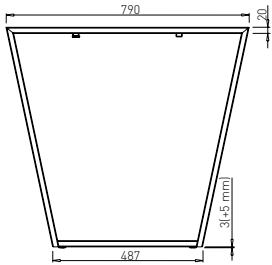

# O-LEG



## O-LEG

30656 | RAL 9006G

20656 | RAL 9005FE

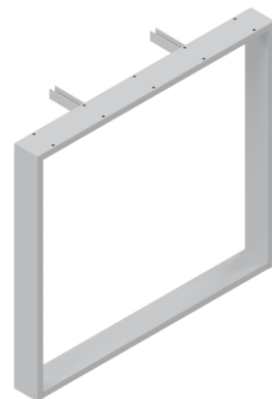
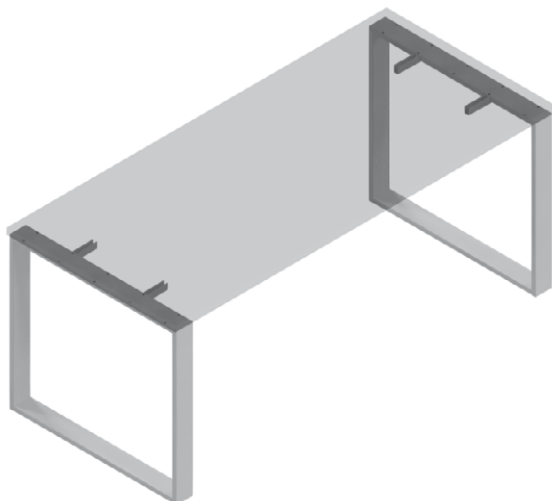
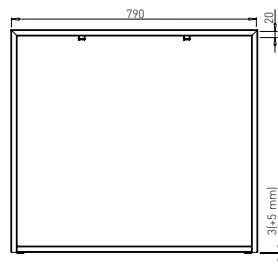

# IPSO



## IPSO

31396 | RAL 9006G  
21396 | RAL 9005FE

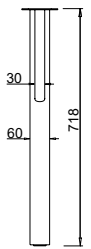
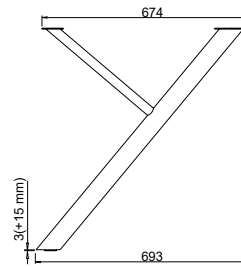

ø800 mm

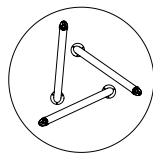

ø1200 mm

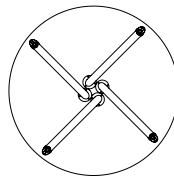

ø1400 mm

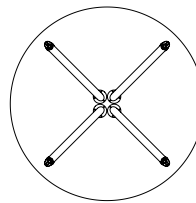

ø1600 mm

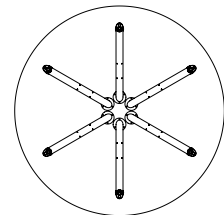

ø1800 mm

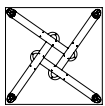

800 x 800 mm

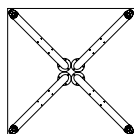

1050 x 1050 mm

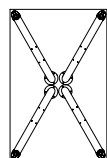

800 x 1250 mm

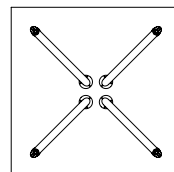

1400 x 1400 mm

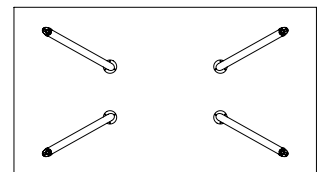

2500 x 1400 mm

# K-IPSO

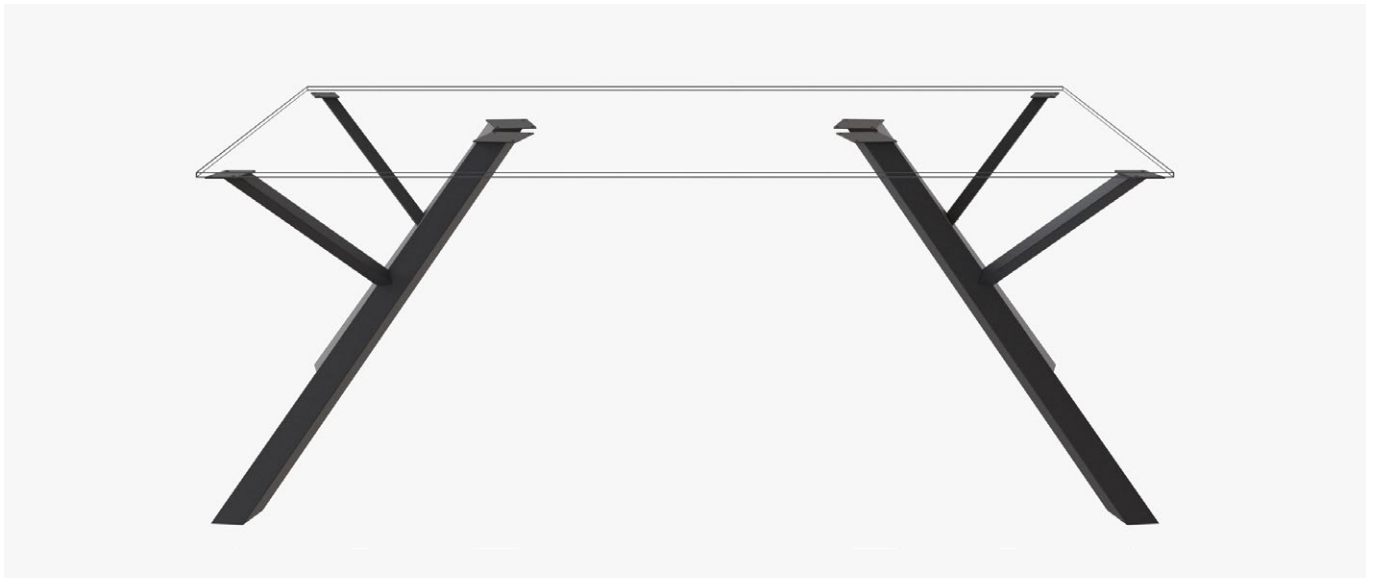

## K-IPSO

31343 | RAL 9006G

21343 | RAL 9005FE

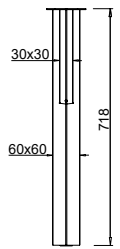
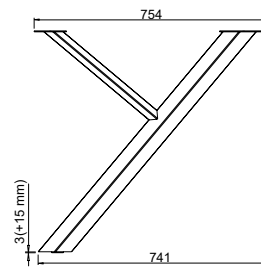

ø800 mm

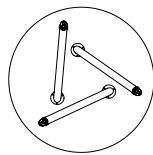

ø1200 mm

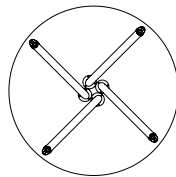

ø1400 mm

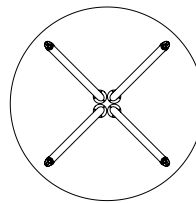

ø1600 mm

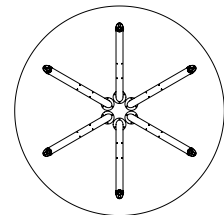

ø1800 mm

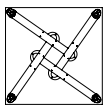

800 x 800 mm

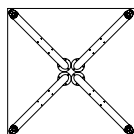

1050 x 1050 mm

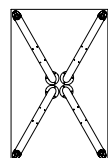

800 x 1250 mm

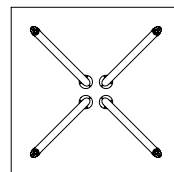

1400 x 1400 mm

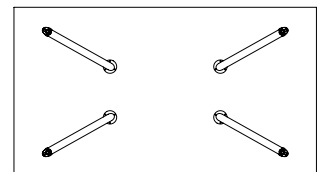

2500 x 1400 mm

# SELF-STANDING TABLE BASES

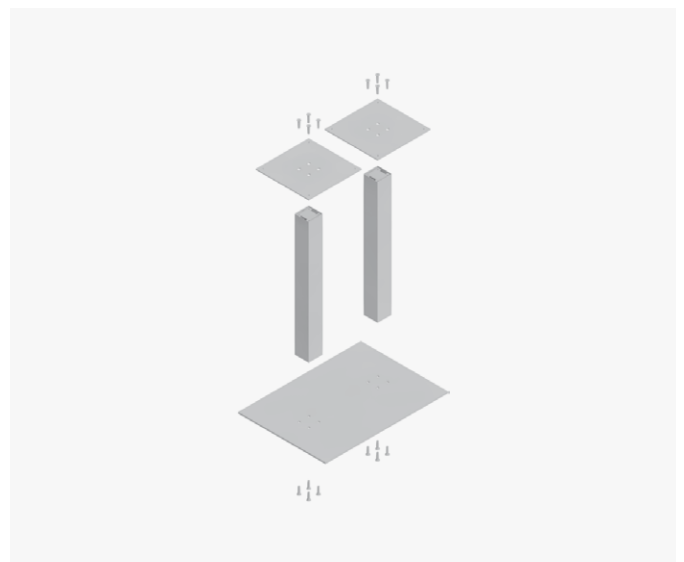
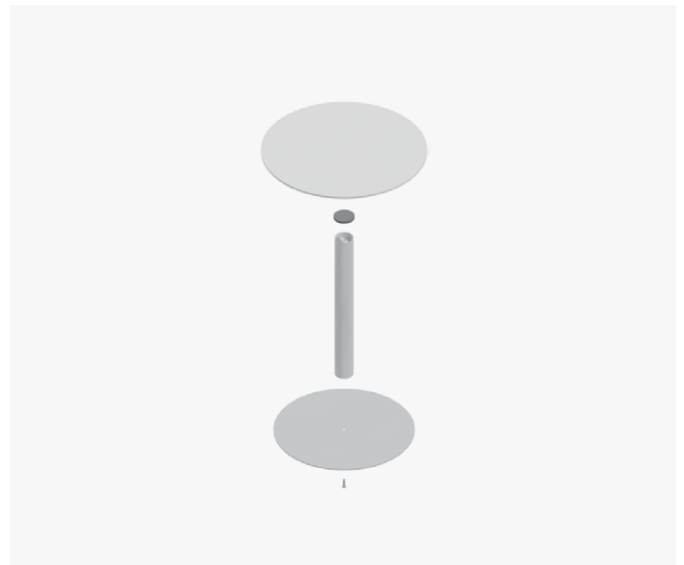

# TERRA



TERRA FOR TABLE TOPS UP TO Ø600 MM AND UP TO 500 X 500 MM

## UP PLATE TERRA 200x200

30120 | RAL 9006G  
20120 | RAL 9005FE

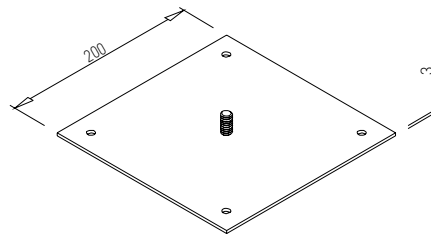

## PLATE TERRA Ø400

30117 | RAL 9006G  
20117 | RAL 9005FE

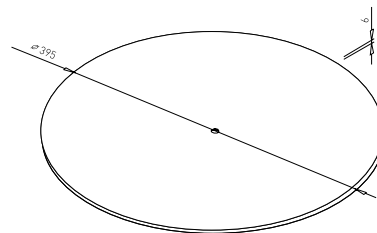

## COLUMN TERRA Ø80 CLUB

30679 | RAL 9006G  
20679 | RAL 9005FE



## COLUMN TERRA Ø80

30115 | RAL 9006G  
20115 | RAL 9005FE

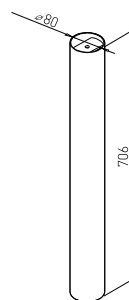

## COLUMN TERRA Ø80 BAR

30841 | RAL 9006G  
20841 | RAL 9005FE



# TERRA



TERRA FOR TABLE TOPS UP TO Ø800 MM AND UP TO 700 X 700 MM

## UP PLATE TERRA 200x200

30120 | RAL 9006G  
20120 | RAL 9005FE

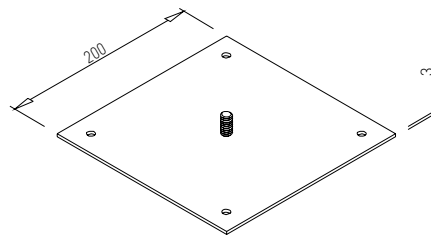

## PLATE TERRA 400x400

30632 | RAL 9006G  
20632 | RAL 9005FE

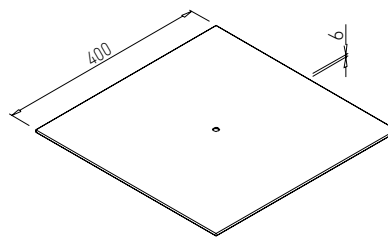

## COLUMN TERRA 50x50

30630 | RAL 9006G  
20630 | RAL 9005FE

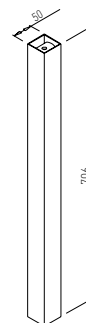

# TERRA



TERRA FOR TABLE TOPS UP TO Ø800 MM AND UP TO 700 X 700 MM

## UP PLATE TERRA 330x330

30162 | RAL 9006G  
20162 | RAL 9005FE

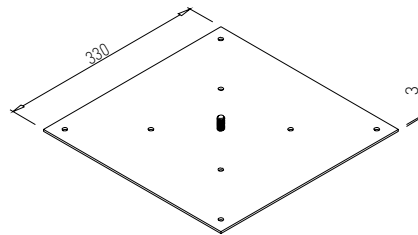

## PLATE TERRA Ø500

30118 | RAL 9006G  
20118 | RAL 9005FE

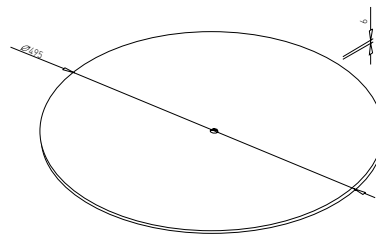

## COLUMN TERRA Ø80

30115 | RAL 9006G  
20115 | RAL 9005FE

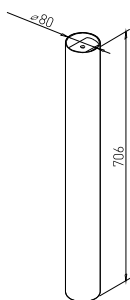

## COLUMN TERRA Ø80 BAR

30841 | RAL 9006G  
20841 | RAL 9005FE



## COLUMN TERRA Ø80 HV

30009 | RAL 9006G  
20009 | RAL 9005FE

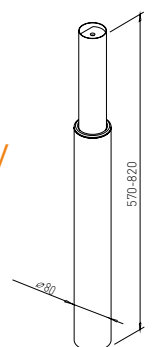

# TERRA



TERRA FOR TABLE TOPS UP TO Ø850 MM AND UP TO 750 X 750 MM

## UP PLATE TERRA 330x330

30162 | RAL 9006G  
20162 | RAL 9005FE

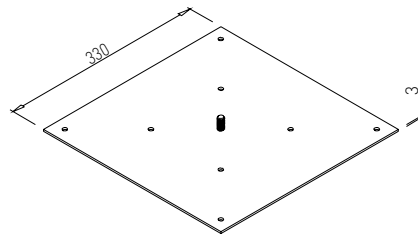

## PLATE TERRA Ø600

30119 | RAL 9006G  
20119 | RAL 9005FE

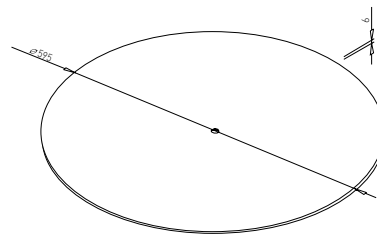

## COLUMN TERRA Ø80

30115 | RAL 9006G  
20115 | RAL 9005FE

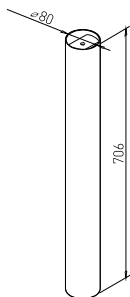

## COLUMN TERRA Ø80 BAR

30841 | RAL 9006G  
20841 | RAL 9005FE



## COLUMN TERRA Ø80 HV

30009 | RAL 9006G  
20009 | RAL 9005FE

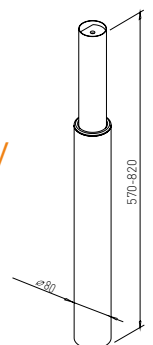

# ACCESSORIES TERRA

## LEVELING TAP $\varnothing 80$

30276 | RAL 7015 plastic

20276 | RAL 9005 plastic

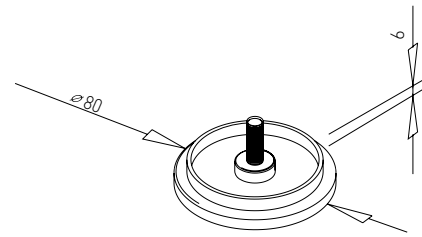

## COVER $\varnothing 500$ TERRA INOX

31105 | Inox

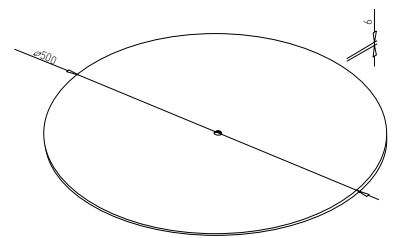

## GLASS HOLDER

20675 | Aluminium

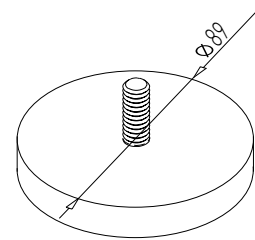

## COLUMN TERRA $\varnothing 80$ INOX

31106 | Inox

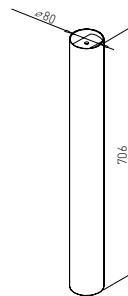



BOMA FOR TABLE TOPS UP TO Ø900 MM AND UP TO 800 X 800 MM

## CROSS BOMA 600

30279 | RAL 9006G

20279 | RAL 9005FE

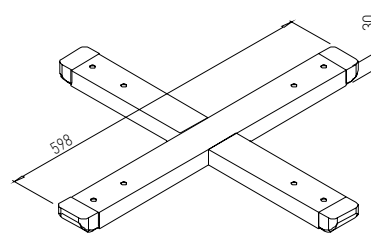

## PLATE BOMA ø550 B

30011 | RAL 9006G

20011 | RAL 9005FE

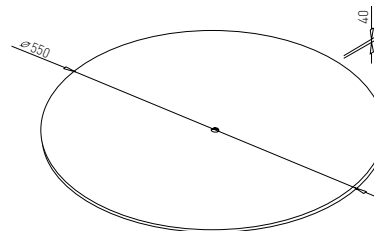

## COLUMN BOMA ø120/ø550

30283 | RAL 9006G

20283 | RAL 9005FE

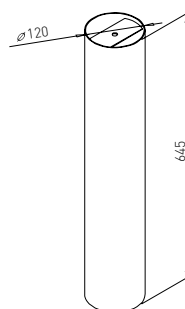



BOMA FOR TABLE TOPS UP TO Ø1100 MM AND UP TO 900 X 900 MM

## CROSS BOMA 600

30279 | RAL 9006G

20279 | RAL 9005FE

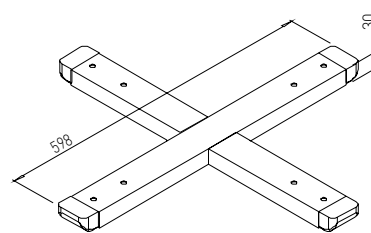

## PLATE BOMA ø620 B

30163 | RAL 9006G

20163 | RAL 9005FE

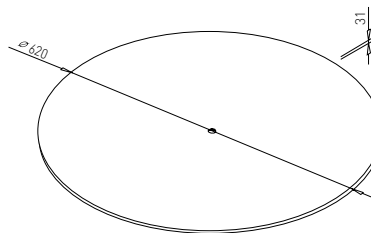

## COLUMN BOMA ø120/ø620

30284 | RAL 9006G

20284 | RAL 9005FE

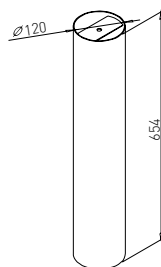

## COLUMN BOMA BAR ø120/ø620

30839 | RAL 9006G

20839 | RAL 9005FE

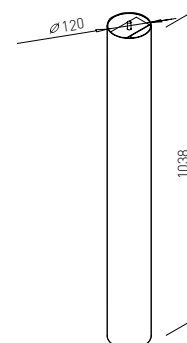



BOMA FOR TABLE TOPS UP TO Ø1100 MM AND UP TO 900 X 900 MM

## CROSS BOMA 600

30279 | RAL 9006G

20279 | RAL 9005FE

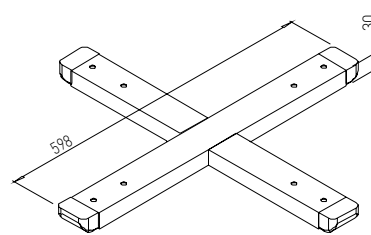

## PLATE BOMA ø620 B

30163 | RAL 9006G

20163 | RAL 9005FE

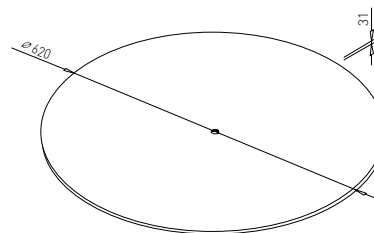

## COLUMN BOMA IRON ø305/ø620

31203 | RAL 9006G

21203 | RAL 9005FE

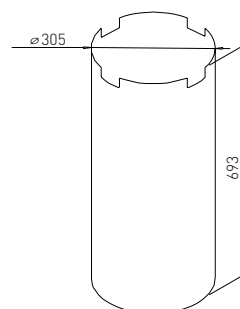



BOMA FOR TABLE TOPS UP TO Ø1300 MM AND UP TO 1050 X 1050 MM

## CROSS BOMA 800

30013 | RAL 9006G  
20013 | RAL 9005FE

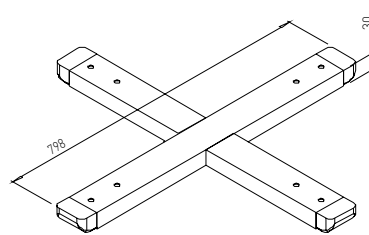

## PLATE BOMA ø720 B

30064 | RAL 9006G  
20064 | RAL 9005FE

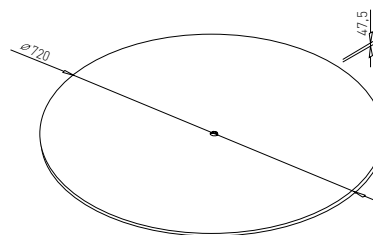

## COLUMN BOMA IRON ø335/ø720

31204 | RAL 9006G  
21204 | RAL 9005FE

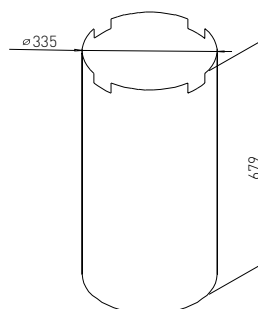



BOMA FOR TABLE TOPS UP TO Ø1600 MM AND UP TO 1200 X 1200 MM

## CROSS BOMA 1000

30278 | RAL 9006G  
20278 | RAL 9005FE

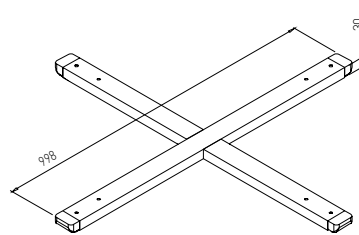

## PLATE BOMA ø820 B

30072 | RAL 9006G  
20072 | RAL 9005FE

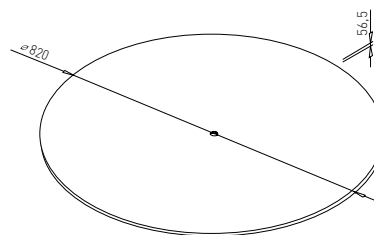

## COLUMN BOMA IRON ø395/ø820

31205 | RAL 9006G  
21205 | RAL 9005FE

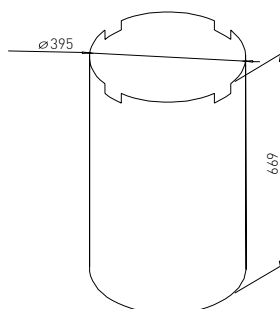



GAST FOR TABLE TOPS UP TO 900 X 900 MM (H=715) OR 800 X 800 MM (H=1100)

## UP PLATE GAST 300x300

31248 | RAL 9006G  
21248 | RAL 9005FE

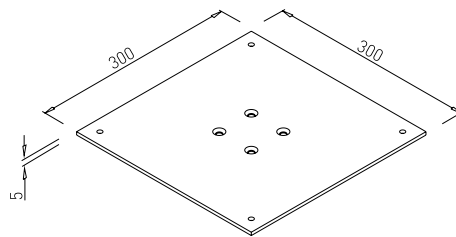

## PLATE GAST 500x500

31247 | RAL 9006G  
21247 | RAL 9005FE

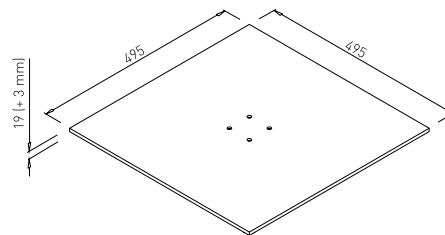

## COLUMN 80x80 GAST

31249 | RAL 9006G  
21249 | RAL 9005FE

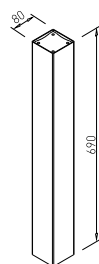

## COLUMN 80x80 GAST BAR

31263 | RAL 9006G  
21263 | RAL 9005FE

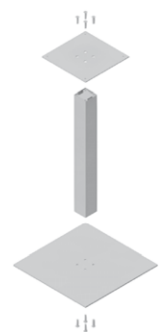
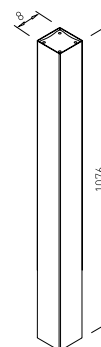



GAST FOR TABLE TOPS UP TO 900 X 1400 MM (H=715) OR 800 X 1200 MM (H=1100)

## UP PLATE GAST 300x300

31248 | RAL 9006G  
21248 | RAL 9005FE

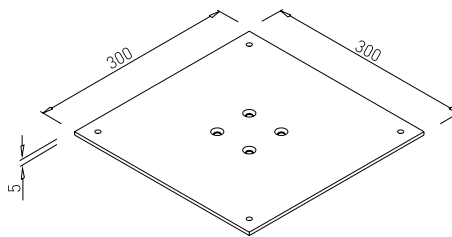

## PLATE GAST 700x500

31261 | RAL 9006G  
21261 | RAL 9005FE

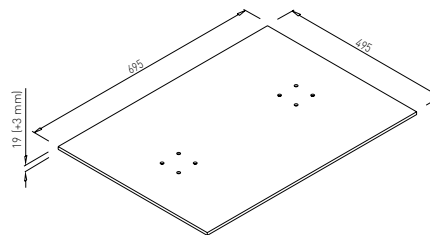

## COLUMN 80x80 GAST

31249 | RAL 9006G  
21249 | RAL 9005FE

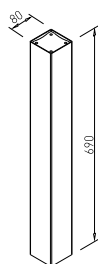

## COLUMN 80x80 GAST BAR

31263 | RAL 9006G  
21263 | RAL 9005FE

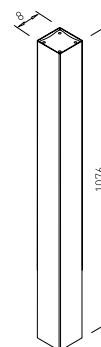



## GAST FOR TABLES WITH TWO LEGS

### UP PLATE GAST 300x300 (with holder)

31264 | RAL 9006G  
21264 | RAL 9005FE

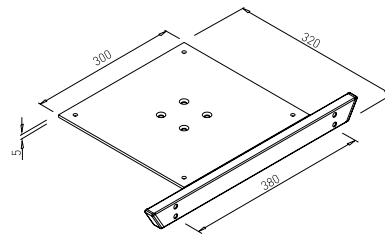

### PLATE GAST 600x300

31262 | RAL 9006G  
21262 | RAL 9005FE

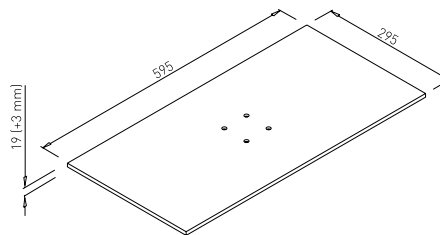

### COLUMN 80x80 GAST

31249 | RAL 9006G  
21249 | RAL 9005FE

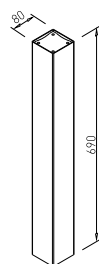

### COLUMN 80x80 GAST BAR

31263 | RAL 9006G  
21263 | RAL 9005FE

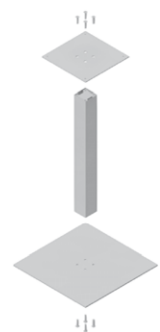
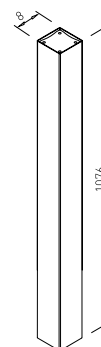

WATCH VIDEO

# CAGE

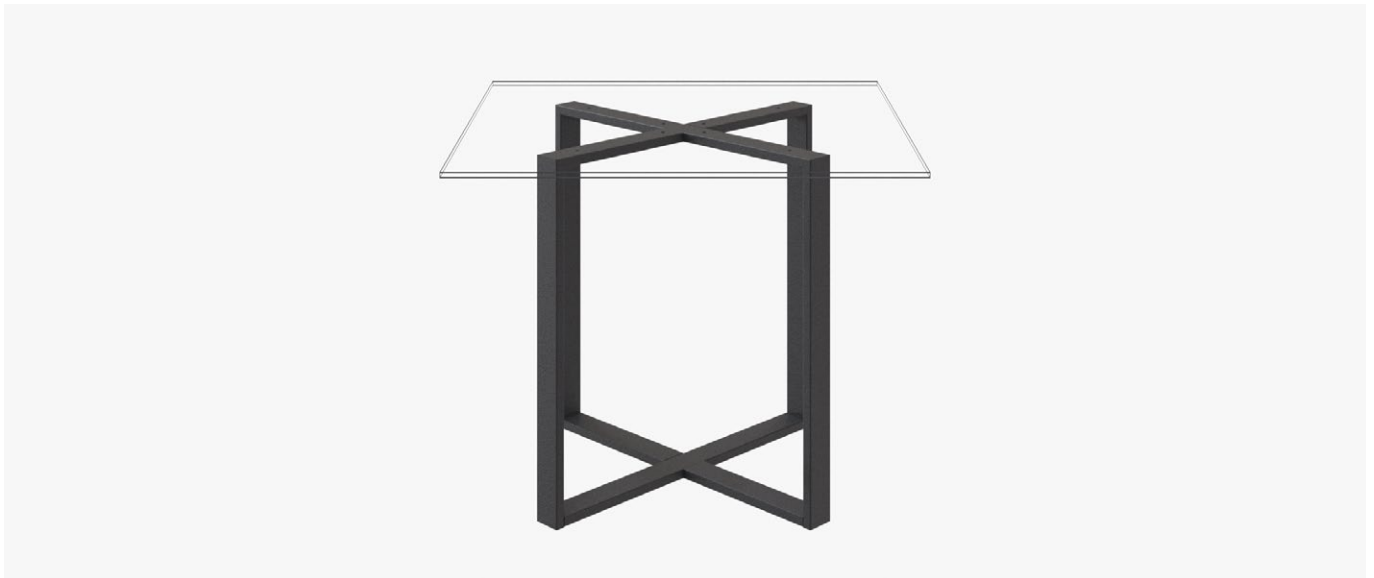

## CAGE

21503 | RAL 9005FE

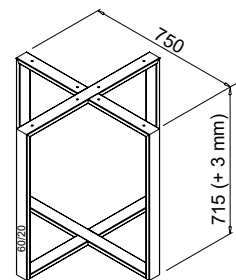
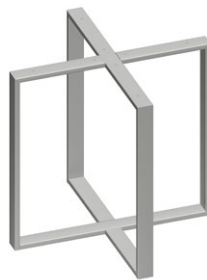

WATCH VIDEO

# CROSS HIFE



## CROSS HIFE

21502 | RAL 9005FE

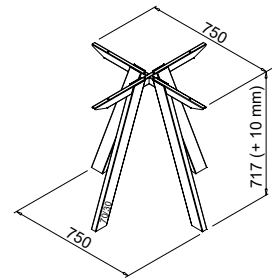
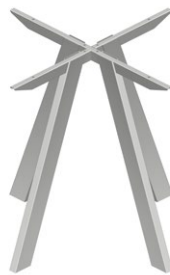

WATCH VIDEO

# DRON



DRON

21504 | RAL 9005FE

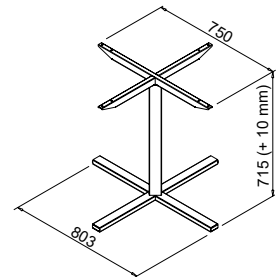

WATCH VIDEO

# SPIKE



## SPIKE

21501 | RAL 9005FE

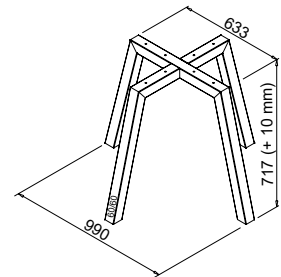
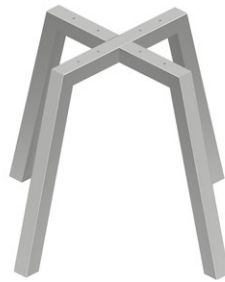

WATCH VIDEO

# TRIPOD



## TRIPOD

21506 | RAL 9005FE

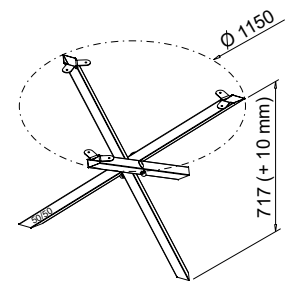

# TEEN BASE



## TEEN BASE

31385 | RAL 9006G  
21385 | RAL 9005FE

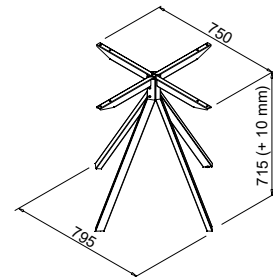

## TEEN BASE BAR

31386 | RAL 9006G  
21386 | RAL 9005FE

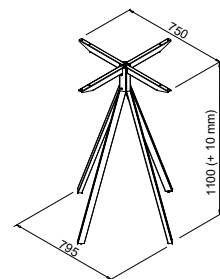

# HUM



## HUM 3

21319 | RAL 9005FE

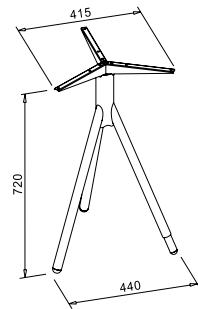

## HUM 4

21320 | RAL 9005FE

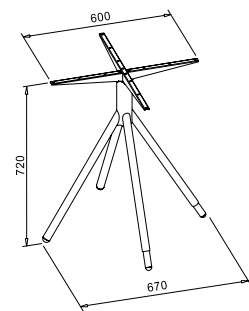

WATCH VIDEO

XXL



XXL

21499 | RAL 9005FE

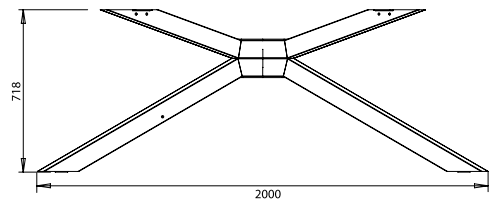
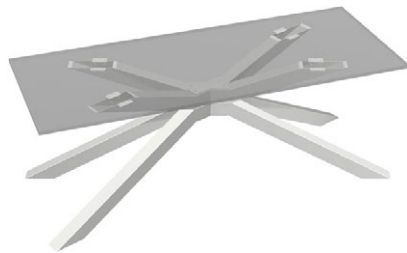

WATCH VIDEO

# XXS



XXS

21500 | RAL 9005FE

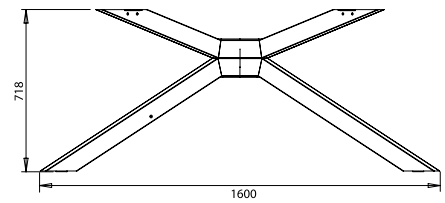
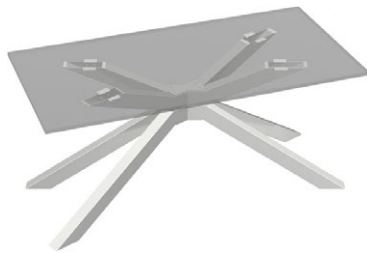

# BXS



BXS

21393 | RAL 9005FE

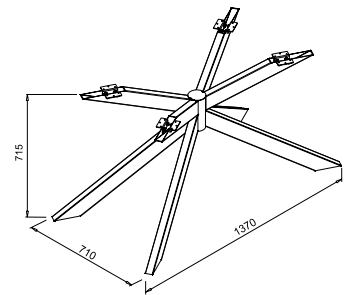

# STAR



STAR

21302 | RAL 9005FE

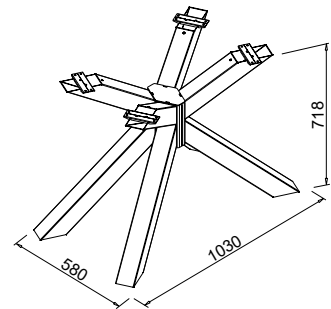
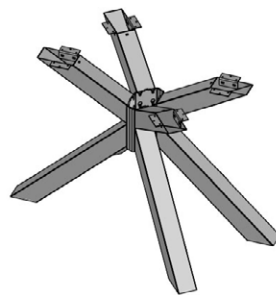

# SPIDER



## SPIDER

21391 | RAL 9005FE

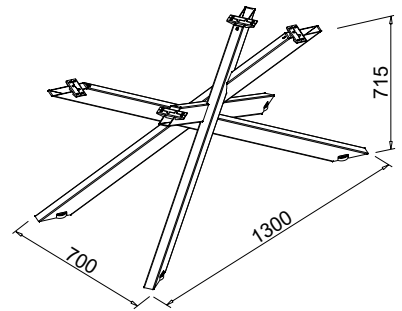

## SPIDER CLUB

21390 | RAL 9005FE

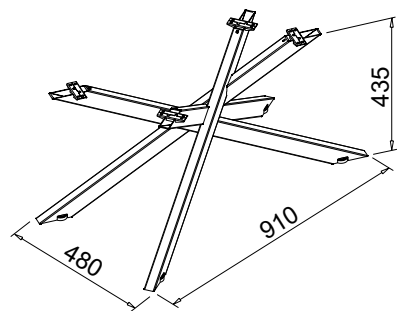

# ELTIPLA



Seat & stand



# ELTIPLA COMPACT



## ELTIPLA COMPACT

21362 | RAL 9005

31362 | RAL 9006

81362 | RAL 9016

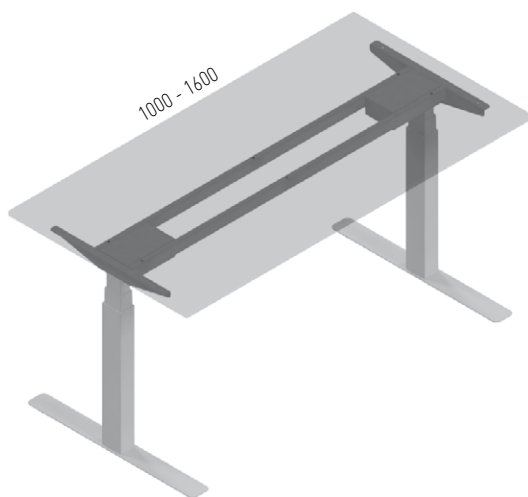
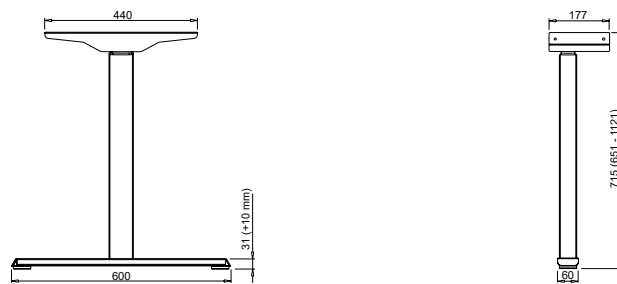

# ELTIPLA 2



## ELTIPLA 2

20987 | RAL 9005

30987 | RAL 9006

80987 | RAL 9016

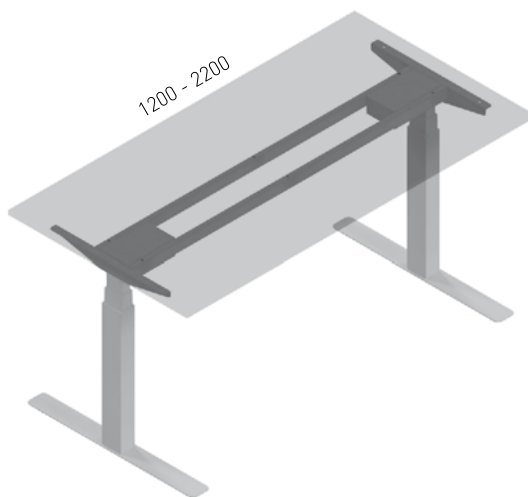
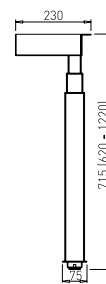
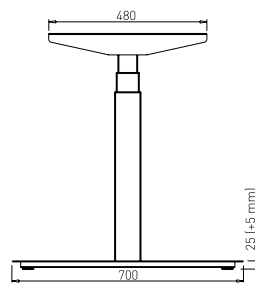

# ELTIPLA 3



## ELTIPLA 3

31265 | RAL 9006

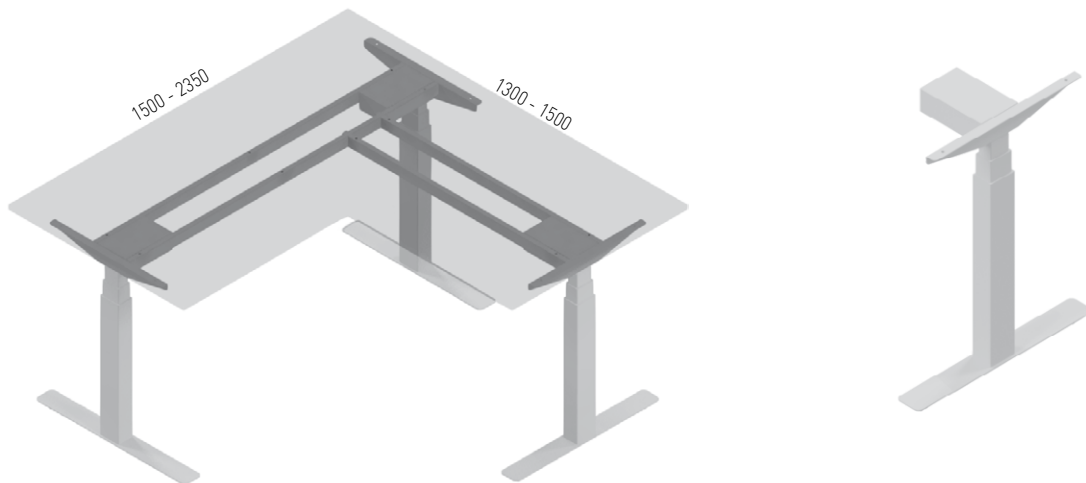
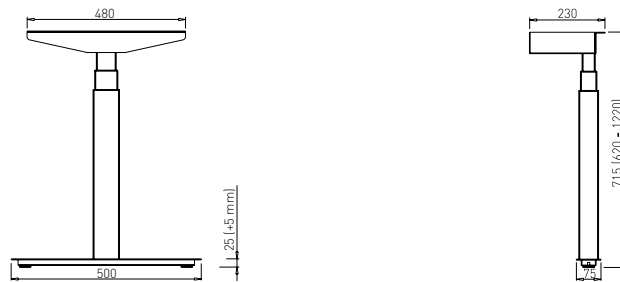



# SHELVING SYSTEM



System GRIDO is a unique spatial construction system for racks, shelves, partitions and side tables.

# GRIDO



## GRIDO

RAL 9006G, RAL 9016FE, RAL 7016FE



---

GRIDO CREATOR is a software tool that allows you to create GRIDO according to your needs.

[CREATE YOUR OWN GRIDO](#)



# HANGERS



VOGA hangers will make your hallway, bedroom or office not only useful but beautiful as well.

# AGAWA



## VOGA AGAWA

**21300** | RAL 9005

**81300** | RAL 9016

981 × 306 × 35 cm | Powder coated steel,  
solid oak | Design: Ernest Nograšek

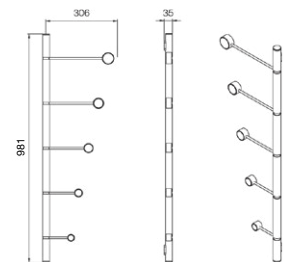
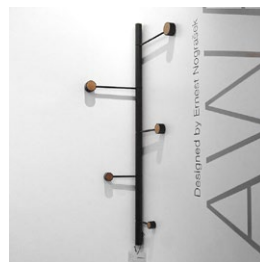

# THORN



## VOGA THORN

**30393** | 35 × 35 × 210 cm | RAL 9005FE  
Steel, powder coating | Solid oak, natural oil



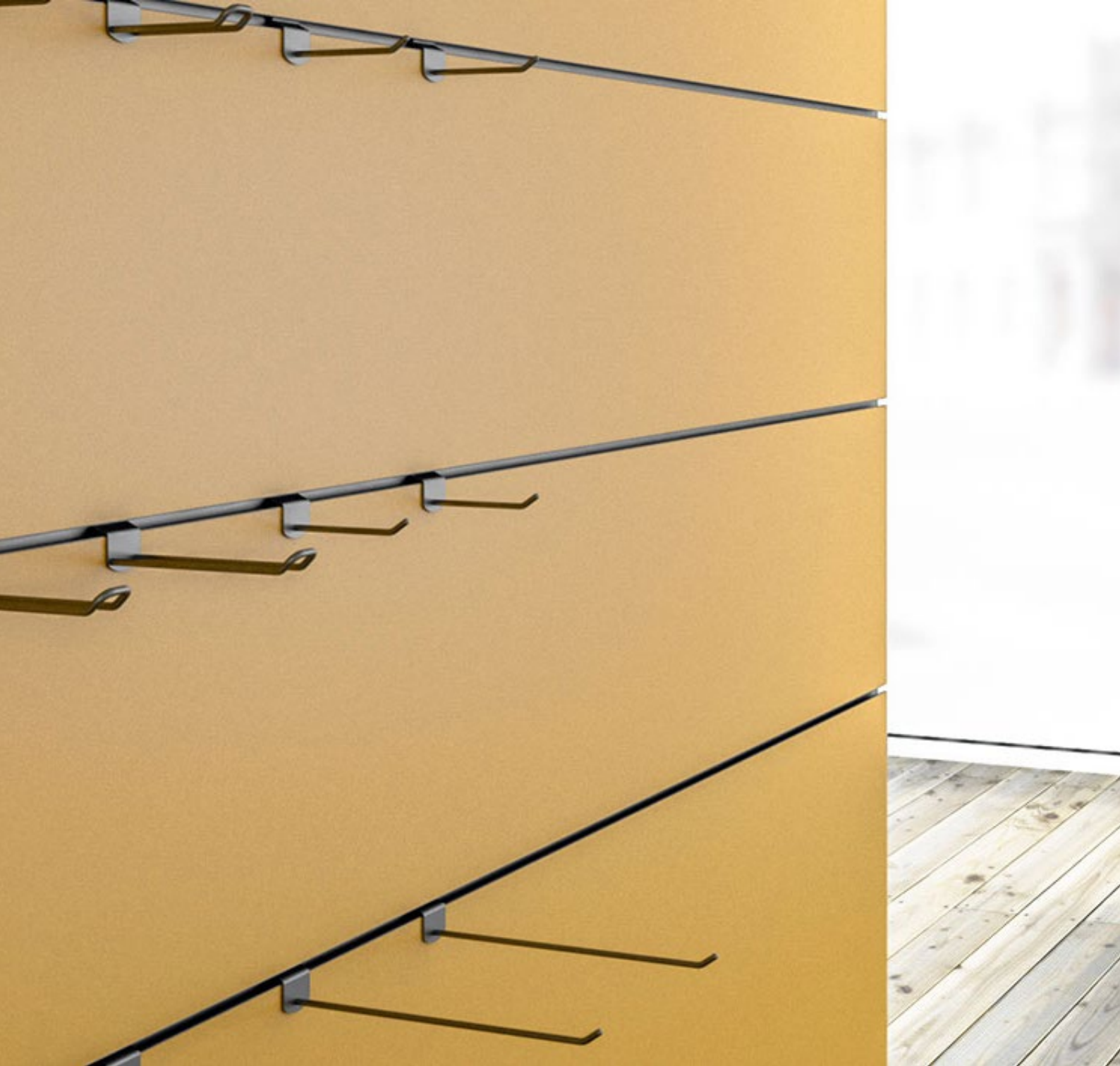

# HANGING WALL



System WALL provides well-ordered walls in offices, apartments and shops.

# PROFILES

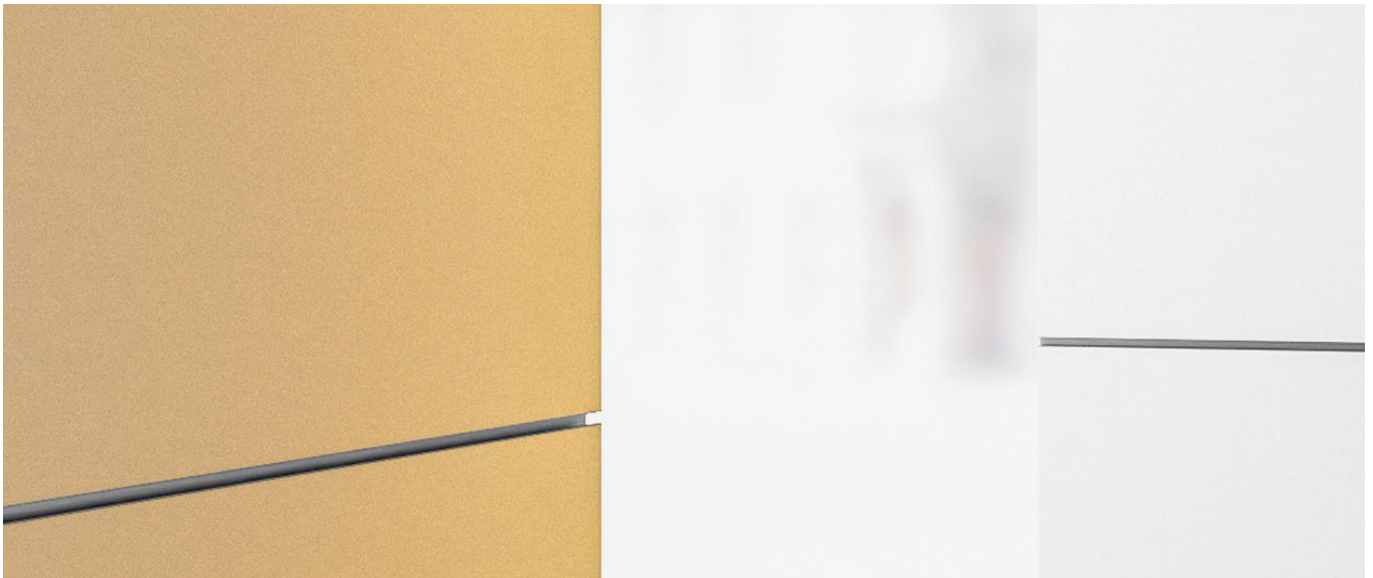

## WALL PROFILE AL

20678 | Aluminium

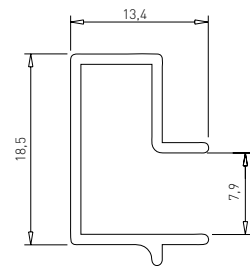
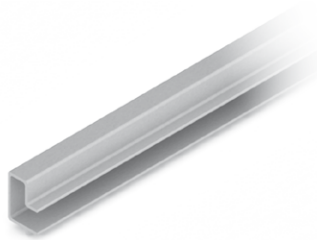

## WALL PROFILE AL DOUBLE

20053 | Aluminium

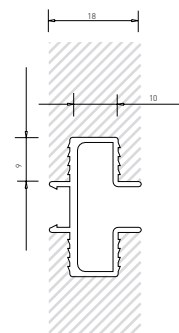
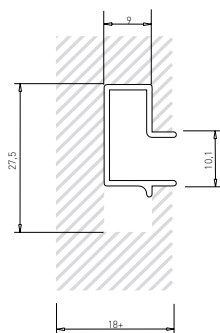
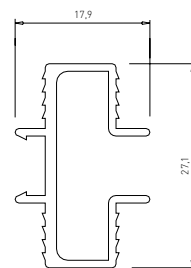
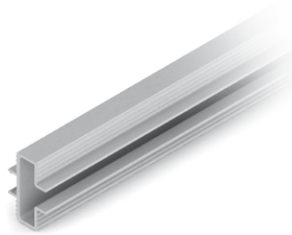

# ATTACHMENTS



## SHELF SUPPORTER

30681 | RAL 9006G

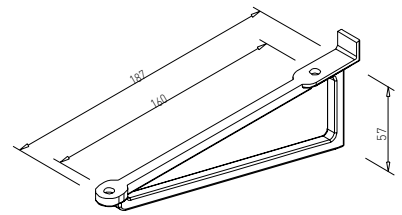
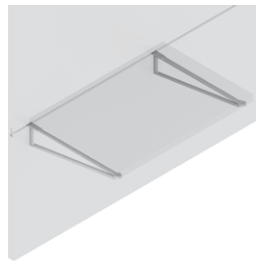

## GLASS SUPPORTER

30545 | Plastic

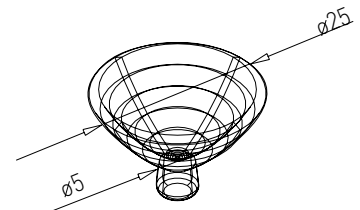
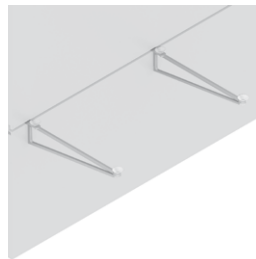

## SUPPORTER POT

30685 | RAL 9006G

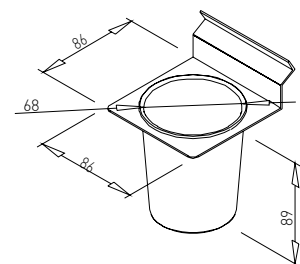
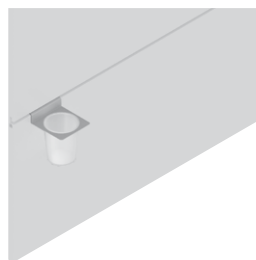

---

## SUPPORTER A4

30686 | RAL 9006G

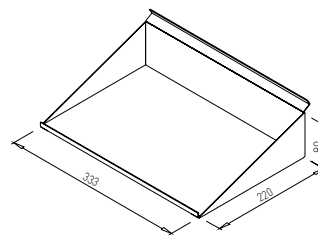
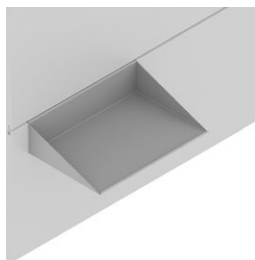

---

## SUPPORTER A4/45

30683 | RAL 9006G

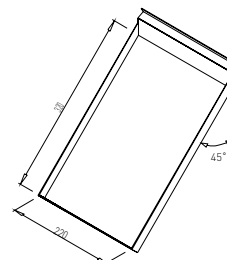
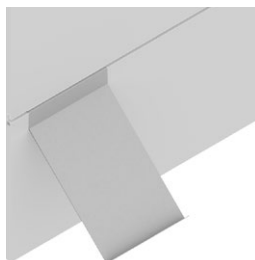

---

## SUPPORTER ADAPTER

30861 | RAL 9006G

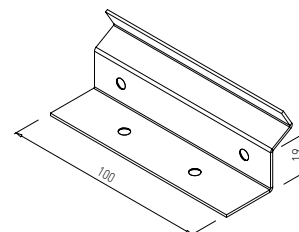
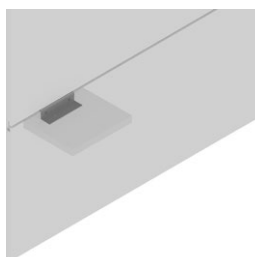

---

## SUPPORTER BOX

30860 | RAL 9006G

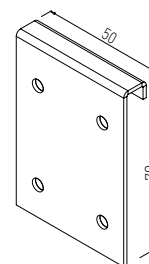
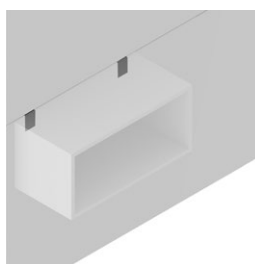

# HANGERS



## SUPPORTER SINGLE 100

31126 | White zinc

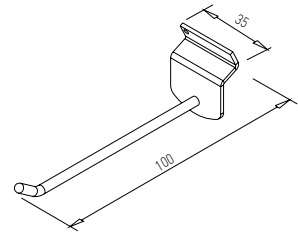

## SUPPORTER DOUBLE 100

31129 | White zinc

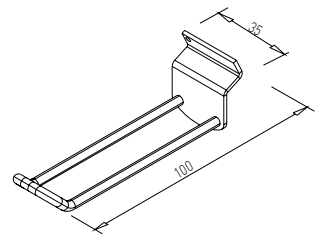
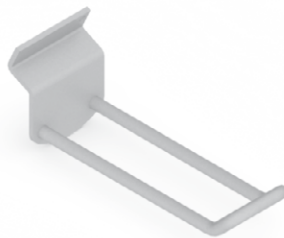

## SUPPORTER SINGLE 150

31125 | White zinc

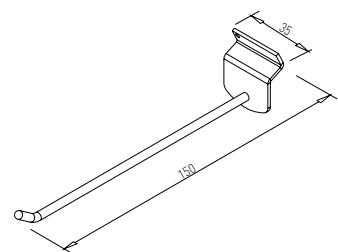
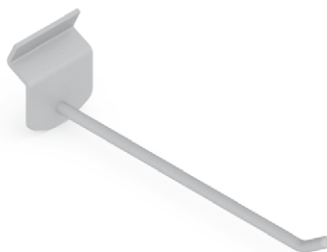

---

**SUPPORTER  
DOUBLE 150**

**31128** | White zinc

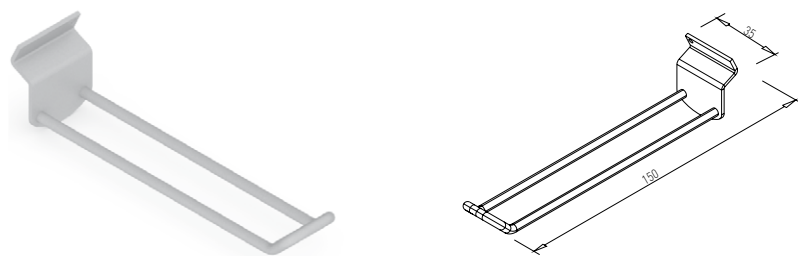

---

**SUPPORTER  
SINGLE 220**

**31124** | White zinc

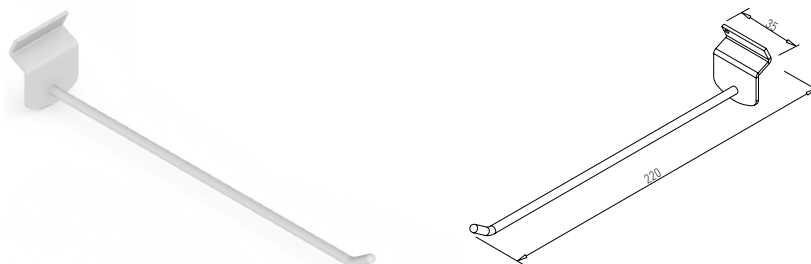

---

**SUPPORTER  
DOUBLE 220**

**31127** | White zinc

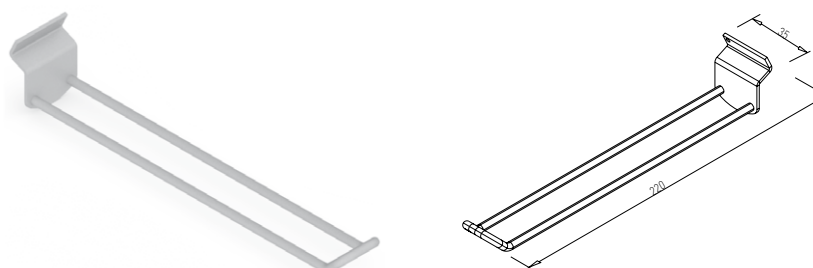



# FURNITURE BASES



Metal furniture bases give the furniture strength, modern look and function for today's time.

# CUBIC/OPTIC



## CUBIC 40x40

30643 | RAL 9006G  
20643 | RAL 9005FE

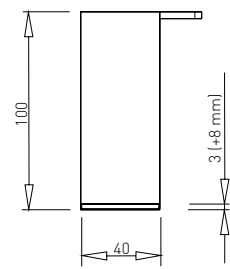

## OPTIC ø40

30699 | RAL 9006G  
20699 | RAL 9005FE

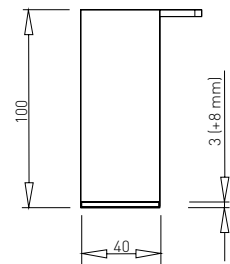

# SILK



## SILK 50 CUBO

30644 | RAL 9006G  
20644 | RAL 9005FE

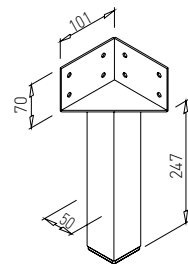

## SILK 80 CUBO

30903 | RAL 9006G  
20903 | RAL 9005FE

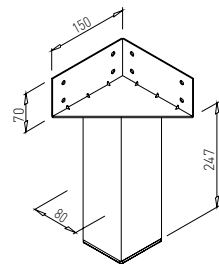

## SILK ø60

30183 | RAL 9006G  
20183 | RAL 9005FE

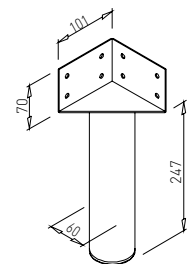

---

## SILK ø80

30121 | RAL 9006G  
20121 | RAL 9005FE

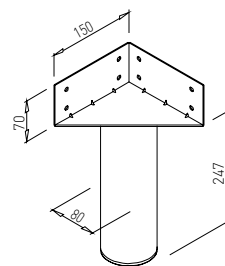

---

## ANGULAR ELEMENT SILK

30180 | RAL 9006G  
20180 | RAL 9005FE

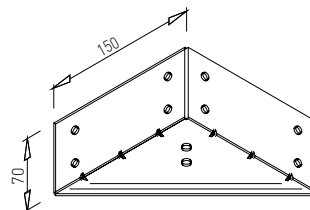
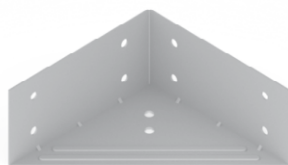

---

## BACK HOLDER SILK

30091 | RAL 9006G  
20091 | RAL 9005FE

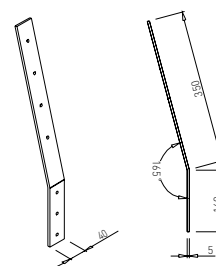



# ACCESSORIES



Designed for all VOGA systems (cable shelves, blinds, trolleys, wheels, ladders and railings)

# ACCESSORIES FOR ALL SYSTEMS

## CABLE HOLDER

20048 | Plastic

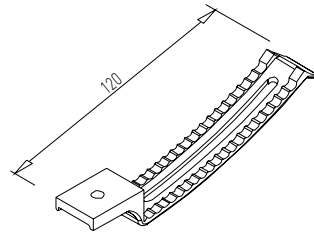

## DOUBLE CABLE HOLDER

20640 | Plastic

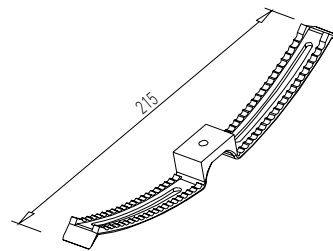

## CABLE TUBE $\varnothing 72$

30077 | RAL 9006G

20077 | RAL 9005FE

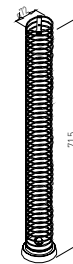
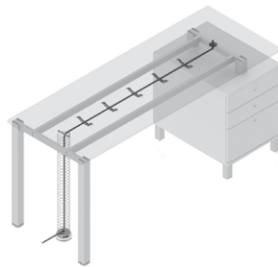

## CABLE SHELF

30525 | RAL 9006G

20525 | RAL 9005FE

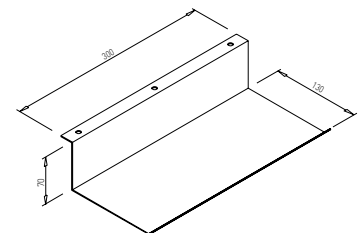
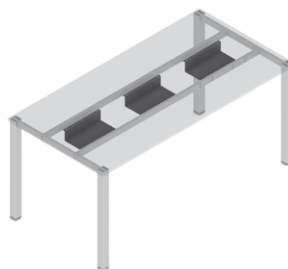

## ANGULAR CONNECTING PLATE

30705 | RAL 9006G

20705 | RAL 9005FE

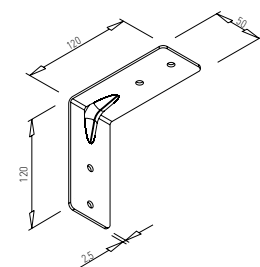

## BLIND

30093 | RAL 9006G

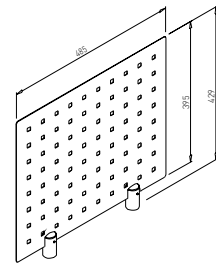
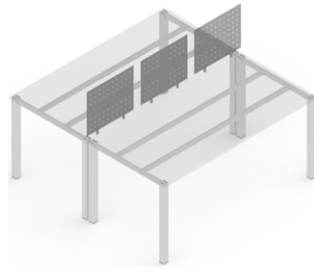

## COMPUTER TROLLEY

30641 | RAL 9006G

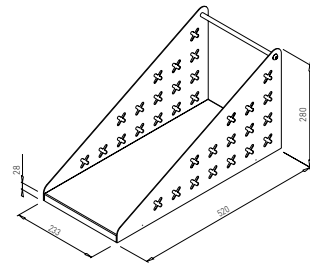

## FURNITURE WHEEL WITH PLATE 42x42

20677 | plastic

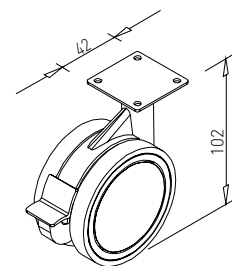

## BUNK BED LADDER V

30692 | RAL 9006G

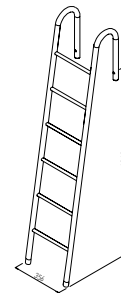

## BUNK BED FENCE V

30693 | RAL 9006G

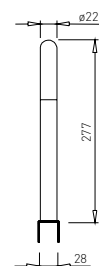
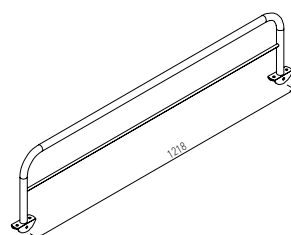

## PERFORATED BACK

Product name	Length	RAL 9006G
BACK 800	700 mm	30165
BACK 1000	900 mm	30166
BACK 1200	1100 mm	30167
BACK 1400	1300 mm	30168
BACK 1600	1500 mm	30169
BACK 1800	1700 mm	30170
BACK 2000	1900 mm	30171

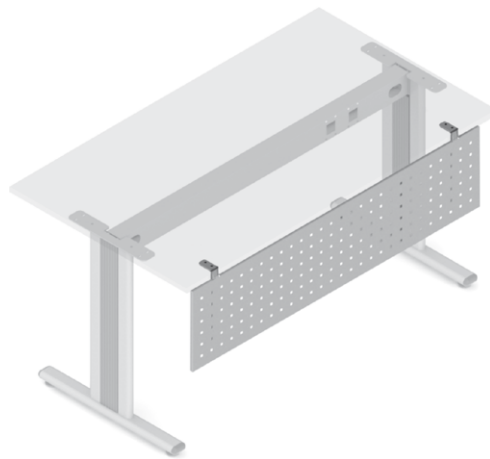

## BACK HOLDER

30030 | RAL 9006G

20030 | RAL 9005FE

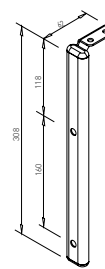





voga.si